

CELLULAR SHADES COLLECTION

Including Pleated Shades / Odysee™ Cellular Blinds / Custom Graphic Shades



**SIMPLICITY
RECHARGEABLE
MOTORIZED**
Option

2018

Manufacturer's Price List and Reference Guide | *Effective April 1st*



www.midwestdesignersupply.com

888-523-2611
262-524-1007 (fax)



Comfortex
WINDOW FASHIONS

Comfortex Cellular, Prelude Shades and Cellular Blinds

Price List and Reference Guide | Effective April 1, 2018

This price list and reference guide contains product pricing, product specifications and technical information for the complete line of Comfortex Cellular, Prelude Shades and Odysee Cellular Blinds.

Cellular and Prelude Shades Overview

Features At A Glance	5
Key Features	6-7
Fabric Collections	8
Upgrade Options	9
Size Standards	10-12
Product Options Availability	13-14
Shade Stack Heights	15-16

Rectangular

Light Filtering: Boutique 3/4", Linen Weave 3/4" and Verona 3/4"	Price Group 1	17
Room Darkening: Boutique 3/4", Linen Weave 3/4" and Verona 3/4"	Price Group 2	18
Premiere 1/2" Light Filtering	Price Group 3	19
Premiere 1/2" Blackout	Price Group 4	20
Premiere 3/4" Light Filtering	Price Group 5	21
Premiere 3/4" Blackout	Price Group 6	22
Debut 1/2" Single Light Filtering	Price Group 7	23
Debut 3/4" Light Filtering	Price Group 8	24
Debut 1/2" Double Light Filtering	Price Group 8	24
Symphony 3/8" Light Filtering	Price Group 9	25
Symphony 3/8" Blackout	Price Group 10	26
Prelude 3/4" Light Filtering	Price Group 11	27
Prelude 3/4" Blackout	Price Group 12	28

Ovation Cellular Sliders

Size Standards - Ovation Cellular Slider Shades	29	
Ovation Cellular Slider Shades Light Filtering	Price Group 13	30
Prelude Ovation Cellular Slider Shades Light Filtering	Price Group 14	30
Ovation Cellular Slider Shades Room Darkening	Price Group 15	31
Prelude Ovation Cellular Slider Shades Blackout	Price Group 16	31

Specialty Shaped Shades

Starburst™ Arches and Quarter Rounds

Size Standards - Specialty Shaped Shades	33-34	
Boutique 3/4" Light Filtering, Debut 1/2" Single Light Filtering, Debut 1/2" Double Light Filtering, Debut 3/4" Light Filtering, Linen Weave 3/4" Light Filtering, Premiere 1/2" Light Filtering, Premiere 3/4" Light Filtering, Symphony 3/8" Light Filtering and Flame Resistant, and Verona 3/4" Light Filtering	Price Group 17	35
Prelude 3/4" Light Filtering	Price Group 18	35
Boutique 3/4" Room Darkening, Linen Weave 3/4" Room Darkening, Premiere 1/2" Blackout, Premiere 3/4" Blackout, Symphony 3/8" Blackout and Verona 3/4" Room Darkening	Price Group 19	36
Prelude 3/4" Blackout	Price Group 20	36

Sunset™ Arches

Verona 3/4" Light Filtering, Boutique 3/4" Light Filtering, Debut 1/2" Single Light Filtering, Debut 3/4" Light Filtering, Debut 1/2" Double Light Filtering, Linen Weave 3/4" Light Filtering, Premiere 1/2" Light Filtering, Premiere 3/4" Light Filtering, Symphony 3/8" Light Filtering and Flame Resistant	Price Group 21	37
--	---------------------------------	----

Prelude 3/4" Light Filtering	Price Group 22	37
Boutique 3/4" Room Darkening, Linen Weave 3/4" Room Darkening, Premiere 1/2" Blackout, Premiere 3/4" Blackout, Symphony 3/8" Blackout and Verona 3/4" Room Darkening	Price Group 23	38
Prelude 3/4" Blackout	Price Group 24	38

Trapezoids and Octagons

Boutique 3/4" Light Filtering, Debut 1/2" Single Light Filtering, Debut 1/2" Double Light Filtering, Debut 3/4" Light Filtering, Linen Weave 3/4" Light Filtering, Premiere 1/2" Light Filtering, Premiere 3/4" Light Filtering, Symphony 3/8" Light Filtering and Flame Resistant, Verona 3/4" Light Filtering	Price Group 25	39
Prelude 3/4" Light Filtering	Price Group 26	39
Boutique 3/4" Room Darkening, Linen Weave 3/4" Room Darkening, Premiere 1/2" Blackout, Premiere 3/4" Blackout, Symphony 3/8" Blackout and Verona 3/4" Room Darkening	Price Group 27	40
Prelude 3/4" Blackout	Price Group 28	40

Soprano® Skylights and Greenhouse Shades

Size Standards - Skylight and Greenhouse Shades	41	
Debut 1/2" Light Filtering, Symphony 3/8" Light Filtering and Flame Resistant	Price Group 29	42

Balcony™ Shading System

Debut 1/2" Light Filtering, Symphony 3/8" Light Filtering and Flame Resistant.	Price Group 30	43
Symphony 3/8" Blackout	Price Group 31	44

Mezzo Motorized Skylight Shading System

Boutique 3/4" Light Filtering, Debut 1/2" Single Light Filtering, Debut 3/4" Light Filtering, Debut 1/2" Double Light Filtering, Linen Weave 3/4" Light Filtering, Premiere 1/2" Light Filtering, Premiere 3/4" Light Filtering, Symphony 3/8" Light Filtering and Flame Resistant, and Verona 3/4" Light Filtering	Price Group 32	45
Boutique 3/4" Room Darkening, Linen Weave 3/4" Room Darkening, Premiere 1/2" Blackout, Premiere 3/4" Blackout, Symphony 3/8" Blackout, and Verona 3/4" Room Darkening	Price Group 33	46

Prelude Skylight Shading System

Prelude 3/4" Light Filtering	Price Group 34	47
Prelude 3/4" Blackout	Price Group 35	47

French Door Décor

Size Standards - Door Decor Hardware Shades	48
---	----

Non-Movable

Boutique 3/4" Light Filtering, Debut 1/2" Single Light Filtering, Linen Weave 3/4" Light Filtering, Premiere 1/2" Light Filtering, Symphony 3/8" Light Filtering and Flame Resistant, and Verona 3/4" Light Filtering	Price Group 36	49
---	---------------------------------	----

Movable

Debut 1/2" Single Light Filtering, Premiere 1/2" Light Filtering, Symphony 3/8" Light Filtering and Flame Resistant	Price Group 37	50
--	---------------------------------	----

Non-Movable

Boutique 3/4" Room Darkening, Linen Weave 3/4" Room Darkening, Premiere 1/2" Blackout, Symphony 3/8" Blackout and Verona 3/4" Blackout	Price Group 38	51
---	---------------------------------	----

Movable

Premiere 1/2" Blackout and Symphony 3/8" Blackout	Price Group 39	52
---	---------------------------------	----

Hardware - All fabrics except Prelude

Standard and Deluxe Cord Lock Shades	53-54
Cord Loop Hardware System	55-56
Cordless Ultra Hardware System	57-58
Cordless Lift & Lock	59-60
Simplicity Motorized Cellular Shades	61-62
Rechargeable Simplicity Motorized Cellular Shades	63-65
NEW Motorized Top Down-Bottom Up Shades	66-67
Simplicity Smart Controller	68
Rechargeable PowerTouch Motorized Cellular Shades	69-70
Ovation Cellular Slider	71-72
Insulating SlumberShades	73-74
Starburst Arches	75
Sunset Arches	76-77
Quarter Rounds	78-79
Trapezoids and Octagons	80-81
Soprano Skylights and Greenhouse Shades	82-83
Balcony Shading System	84-85
Mezzo Motorized Skylight Shading System	86-87
Door Decor	88-89
Day - Night Shades	91-92

Custom Graphics

Custom Graphics	93
---------------------------	----

Hardware - Prelude

Prelude Standard Cord Lock Shades	94-95
Prelude Cord Loop Hardware System	96-97
Prelude Cordless Ultra Hardware System	98-99
Prelude Cordless Lift & Lock	100-101
Prelude Simplicity Motorized Cellular Shades	102-103
Prelude Rechargeable Simplicity Motorized Cellular Shades	104-106
Prelude Rechargeable PowerTouch Motorized Cellular Shades	107-108
Prelude Ovation Cellular Slider	109-110
Prelude Starburst Arches	111
Prelude Sunset Arches	112-113
Prelude Quarter Rounds	114
Prelude Trapezoids and Octagons	115-116
Prelude Skylight Shading System	117

Cellular Shades General Information

Highlights Cornice Valances	118
Fabric Characteristics	118
Cut-Outs	118
Scotchgard Protection	119
Certified Fabrics	119
Symphony Flame Resistant Fabrics	119
EZ Level	119
Cleaning and Care	120
Measuring Instructions	130
Measuring Specialty Shades	130
Making the Perfect Template	131

Odysee Cellular Blinds

Key Features	122
Features At A Glance	122
Odysee Light Filtering	123
Odysee Hardware	124
Operating Odysee Blinds	129
Operating Cords	125
Stack Heights	125

Price Group 40

Odysee Vane Characteristics	125
Cordless PowerTouch Push Button Control	126
Motorized Odysee Cellular Blinds	127
Rechargeable Motorized Odysee Cellular Blinds	128
Odysee Certified Fabrics	129
Measuring Instructions for Odysee Cellular Blinds	129
Cleaning and Care of Odysee Cellular Blinds	129

Policies and Warranty





Child Safety	132
Conditions Of Sale	132
Policies	132
Custom Graphics Cellular Shades Color Warranty	133
Scotchgard™ Warranty	134
Cellular Shades and Odysee Cellular Blinds Warranty Information	134-135
Motorized Shades Warranty	135

Cellular Shades



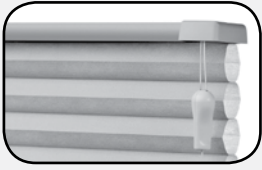

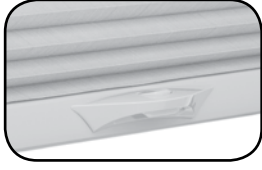

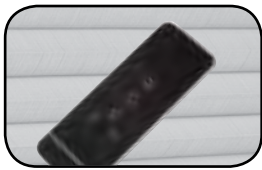
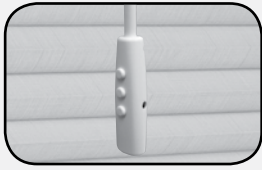

- Originally created as a solution to excessive heat loss or gain in greenhouses and solariums, Comfortex Cellular Shades are energy efficient and provide comfort in all seasons and climates.
- Durable, washable, dust resistant and light diffusing-our non-woven polyester cellular fabrics are a balance of dynamic form and life lasting function.
- Select what meets your creative desire for every room in your home knowing that all our light filtering cellular and blackout fabrics are pure white to the outside (except duotone fabrics).
- Color Coordinated components compliment the shade fabric for a cohesive look .
- Create a designer look with the Designer Oil Rubbed Bronze and Brushed Nickel Hardware on shades using standard or Deluxe Cord Lock Rail, Cord Loop and Cordless Ultra Hardware.
- In addition to superior insulation, Comfortex window shades eliminate virtually 100% of the ultraviolet light that can destroy the texture and color of your valuable home furnishings - yet our colors never fade.
- Comfortex Ovation allows select Energy Smart Double and Single Honeycomb Cellular Fabrics to be used in vertical applications where sliding window treatments are ideal: over doors, wide windows and as room dividers.
- Comfortex Cellular Shades with the Motorized Lift utilize the Simplicity System. The motors will fully operate the shades with radio frequency technology.
- Simplicity Shades can be powered by a discrete and easy to use custom rechargeable battery pack. Simplicity Shades can be operated for up to one full year on a single charge. And, you can recharge the batteries up to 500 times! Simply plug the charger into the charging port on the shade and plug into a standard household outlet to recharge overnight.
- Scotchgard™ protection exclusively from Comfortex available on Linen Weave Cellular shades. Comfortex Window Fashions provides a limited warranty for fabrics treated with 3M Scotchgard™ Protector against permanent stains for a period of one year from the date of original purchase.
- A limited lifetime warranty is our commitment to your satisfaction.

Cellular and Pleated Shade Hardware Options

	Key Features	Color Options	Hardware Size (Depth x Height)	Widths & Lengths*	More Information
Cord Lock 	<ul style="list-style-type: none"> Reliable cord lock Sleek, color coordinated rails UV resistant materials 	<ul style="list-style-type: none"> Color Coordinated Fabric Wrapped Brushed Nickel Oil Rubbed Bronze 	Standard Head Rail: 1 7/8" x 1/2" Deluxe Head Rail: 2 3/8" x 1/2"	Width: 8" to 120" Length: 8" to 120"	Page 53
Cord Loop 	<ul style="list-style-type: none"> Great for large windows Smooth & quiet operation 	<ul style="list-style-type: none"> Color Coordinated Fabric Wrapped Brushed Nickel Oil Rubbed Bronze 	2 1/4" x 1 1/2"	Width: 14" to 120" Length: 8" to 120"	Page 55
Cordless Ultra 	<ul style="list-style-type: none"> Child safe No visible cords Smooth & quiet operation Sleek clear handle on rails Two-On-One option available 	<ul style="list-style-type: none"> Color Coordinated Fabric Wrapped Brushed Nickel Oil Rubbed Bronze 	2 1/4" x 1 1/2"	Width: 18" to 120" Length: 8" to 84"	Page 57
Cordless Lift & Lock 	<ul style="list-style-type: none"> Child safe Easy push button operation Rails lock securely in place in any position Color coordinated rails and handle 	<ul style="list-style-type: none"> Color Coordinated Fabric Wrapped Oil Rubbed Bronze 	Standard Head Rail: 1 7/8" x 1/2" Deluxe Head Rail: 2 3/8" x 1/2" Bottom Rail: 1 7/8" x 1 1/8"	Width: 16" to 96" Length: 8" to 84"	Page 59
Simplicity Motorization 	<ul style="list-style-type: none"> Raise & lower shade with click of a button Great for large and hard to reach windows Remote can operate multiple shades 	<ul style="list-style-type: none"> Color Coordinated Fabric Wrapped Oil Rubbed Bronze Brushed Nickel 	2 1/4" x 1 1/2"	Width: 18" to 120" Length: 8" to 120"	Page 61
Simplicity Rechargeable Motorization 	<ul style="list-style-type: none"> Raise & lower shade with click of a button Great for large and hard to reach windows Remote can operate multiple shades Standard or Top Down-Bottom Up 	<ul style="list-style-type: none"> Color Coordinated Fabric Wrapped Oil Rubbed Bronze Brushed Nickel 	2 1/4" x 1 1/2"	Width: 18" to 120" Length: 8" to 120"	Page 63
PowerTouch™ Rechargeable Cordless Wand 	<ul style="list-style-type: none"> Raise & lower shade with push of a button Just "Touch & Go" to operate the shade Set your favorite shade position Easy access to charging port on side of pendant 	<ul style="list-style-type: none"> Wand and pendant available in white or black 	2 1/4" x 1 1/2"	Width: 18" to 120" Length: 8" to 120"	Page 69

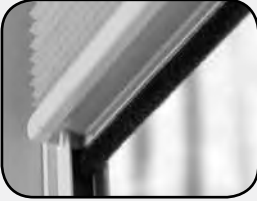
* Maximum widths and lengths listed do not take into account square foot or weight limitations. Make sure to refer to shaded areas on price groups for maximum size availability by fabric style.

Cellular and Pleated Shade Hardware Options

	Key Features	Color Options	Hardware Size (Depth x Height)	Widths & Lengths*	More Information
Ovation™ Slider 	<ul style="list-style-type: none"> Vertically oriented fabric glides across window Shade can stack left, right or center Great for sliding glass doors or room dividers 	<ul style="list-style-type: none"> White (Standard) Ivory Beige Tan Gray 	3 5/8" x 1 3/4"	Width: 12" to 168" Length: 24" to 120"	Page 71
French Door Décor 	<ul style="list-style-type: none"> Great option for narrow windows and doors Available in moveable & non-moveable rails No Pull cords 	<ul style="list-style-type: none"> Color Coordinated Fabric Wrapped Brushed Nickel Oil Rubbed Bronze 	1 7/8" x 1/2"	Width: 6" to 36" Length: 12" to 96"	Page 89
Insulating SlumberShade™ 	<ul style="list-style-type: none"> Ultimate blackout shade Tracks keep out light, cold or heat Perfect for nurseries, day sleepers 	<ul style="list-style-type: none"> Color Coordinated Fabric Wrapped Brushed Nickel Oil Rubbed Bronze Sidetracks are available in white, tan or Bronze 	Dependant on hardware choice	Width: 9" to 96" Length: 8" to 120"	Page 73
Top Down-Bottom Up 	<ul style="list-style-type: none"> Lower shade from top: raise from bottom Great for privacy Ideal for light control Available in Cord Lock, Cord Loop, Cordless and motorized 	<ul style="list-style-type: none"> Color Coordinated Fabric Wrapped Oil Rubbed Bronze Brushed Nickel 	Dependant on hardware choice	Width: 18" to 120" Length: 8" to 120"	See Product Availability Page 13-14
Two on One Head Rail 	<ul style="list-style-type: none"> Operate two shades on one rail Great for larger windows Individually operating shades 	<ul style="list-style-type: none"> Color Coordinated Fabric Wrapped Oil Rubbed Bronze Brushed Nickel 	Dependent on Style See Above	Width: 16" to 144" Length: 8" to 120"	See Product Availability Page 13-14
Highlights Cornice Valance 	<ul style="list-style-type: none"> Adds height to windows Available as inside and outside mount Easy to install 	<ul style="list-style-type: none"> 100+ Envision fabrics 100s of patterns and colors 	Width: 24" x 216" Valance Height: 6" Returns: 1 1/2" x 6"	Varies by selected fabric Width: 12" to 216"	Page 118

* Maximum widths and lengths listed do not take into account square foot or weight limitations. Make sure to refer to shaded areas on price groups for maximum size availability by fabric style.

Make sure to consult specification charts for specific fabric styles.

Comfortex Cellular and Pleated Shade Fabric Collections

Cellular Shade Collection

Fabric Collection	Cell Size and Structure	Opacities	Fabric Content
Boutique	<ul style="list-style-type: none"> • ¾ -Inch • Single Cell 	<ul style="list-style-type: none"> • Light Filtering • Room Darkening 	<ul style="list-style-type: none"> • Light Filtering: Non-Woven Polyester • Room Darkening: Opaque lining pressed between two layers of non-woven polyester • Karma-Light technology insures color on front fabric will not be distorted like traditional blackout shades.
Debut*	<ul style="list-style-type: none"> • ½-Inch Single Cell • ¾-Inch Single Cell • ½-Inch Double Cell 	<ul style="list-style-type: none"> • Light Filtering 	<ul style="list-style-type: none"> • Light Filtering: Non-Woven Polyester
Linen Weave	<ul style="list-style-type: none"> • ¾ -Inch • Single Cell 	<ul style="list-style-type: none"> • Light Filtering • Room Darkening 	<ul style="list-style-type: none"> • Light Filtering: Non-Woven Polyester • Karma-Light technology insures color on front fabric will not be distorted like traditional blackout shades.
Premiere**	<ul style="list-style-type: none"> • ½-Inch • ¾-Inch • Single Cell 	<ul style="list-style-type: none"> • Light Filtering • Blackout 	<ul style="list-style-type: none"> • Light Filtering: Non-Woven Polyester • Blackout: Opaque lining pressed between two layers of non-woven polyester
Symphony	<ul style="list-style-type: none"> • ⅜-Inch • Double Cell 	<ul style="list-style-type: none"> • Light Filtering • Flame Retardant Light Filtering • Blackout 	<ul style="list-style-type: none"> • Light Filtering: Non-Woven Polyester • Blackout: Non-Woven Polyester with foil lining
Verona	<ul style="list-style-type: none"> • ¾ Inch • Single Cell 	<ul style="list-style-type: none"> • Light Filtering • Room Darkening 	<ul style="list-style-type: none"> • Light Filtering: Non-Woven Polyester • Room Darkening: Opaque lining pressed between two layers of non-woven polyester

* Debut Light Filtering fabrics include solid colors, Homespun, Country Woven, Florance, Strata, Angel Hair, Blossom, Strie and Terrazzo.

** Premiere fabrics include the following prints: Spheres and Tuscan Scroll. Premiere Blackout fabrics include the following prints: Homespun, Country Woven, Florance, Strata, Angel Hair and Blossom.

Cellular Shade **Motorized** Pricing Examples

SIMPLICITY MOTORIZATION PRICING EXAMPLE:

Linen Weave	
Light Filtering 42" x 60" Shade:	\$364.00
Simplicity Motor Surcharge:	\$334.00
Simplicity Remote Control:	\$40.00
Total List Price:	\$738.00

SIMPLICITY RECHARGEABLE MOTORIZATION PRICING EXAMPLE:

Linen Weave Light Filtering 42" x 60" Shade:	\$364.00
Simplicity Rechargeable Surcharge:	\$334.00
Plug-In Charger for Battery (required):	\$27.00
Simplicity Remote Control:	\$40.00
Total List Price:	\$765.00

Cellular Shade Hardware Upgrade Options

LIFT SYSTEM	UPGRADES	ADD	DESIGNER UPGRADE OPTIONS	UPGRADES	ADD
Cord Lock	Top Down-Bottom Up	\$64	Add to Any Lift System Upgrade (Chart to the left)	Metallic Hardware	\$22
	Cordless Lift & Lock	Bottom Up		Fabric Wrapped Hardware	\$22
	Top Down-Bottom Up	\$83		Scotchgard Stain Protection	\$35
Cordless Ultra	Bottom Up	\$83		Highlights Valance See Page 118 For More Information	
	Top Down-Bottom Up	\$166			
Cord Loop	Bottom Up	\$83	Light Blocking Sidetrack System	Insulating SlumberShades See Page 73 For More Information	\$134
	Top Down-Bottom Up	\$166			
ADDITIONAL OPTIONS	UPGRADES	ADD			
Add to Any Upgrade Above	Two-On-One Head Rail	\$50	Add to Cord Lock Shade and add lift system upgrade		
	Cut Outs	\$52	Per side		
	Day-Night		Price each separate shade then add together		
Other	Soprano - Two Moving Rails	\$129			
	Ovation Center Stack	\$84			
Accessories	6 Foot Expandable Pole	\$37			
	12 Foot Expandable Pole	\$46			

Cellular Shade **Motorized** Hardware Upgrade Options

MOTORIZED	UPGRADES	ADD	
PowerTouch Rechargeable Motorization System	Rechargeable Integrated Battery Pack	\$110	For More Information Page 69
	Plug-In Charger for Rechargeable Li-Ion	\$27	
Simplicity Motorization System	Motor and Battery Wand	\$334	For More Information Page 61
	Simplicity 5 Channel Remote	\$40	
	Simplicity 6 Channel Remote/Timer	\$65	
	48" Extension Wire	\$18	
	DC Power Supply/Transformer	\$63	
Simplicity Rechargeable Motorization System	Motor with Integrated Li-ion Battery	\$334	For More Information Page 63
	Simplicity 5 Channel Remote	\$40	
	Simplicity 6 Channel Remote/Timer	\$65	
	Plug-In Charger for Rechargeable Li-Ion	\$27	
	NEW Top Down-Bottom Up*	\$535	
	NEW Top Down-Bottom Up 14 Channel Remote**	\$65	
7.4v Solar Panel & Mounting Brackets	\$75		
Simplicity Smart Controller System	NEO Controller	\$330	For More Information Page 68
	NEO Application for Mobile Devices	FREE	

*Upcharge includes motorization plus second motor and Top Down-Bottom Up components

** TDBU Remote required for Motorized Top Down-Bottom Up shades

Size Standards Comfortex Cellular and Pleated Shade Fabric Collections

Cellular Shade Collection

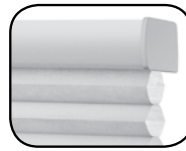
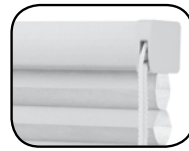
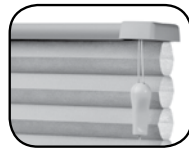

	Minimum	Cord Lock		Cord Loop		Cordless Ultra		Cordless Lift & Lock	
		Bottom Up	Top Down Bottom Up	Bottom Up	Top Down Bottom Up	Bottom Up	Top Down Bottom Up	Bottom Up	Top Down Bottom Up
		ALL FABRICS (except 3/4" Prelude)	Minimum Width	8"	12"	14"	22"	15" OB or 15 3/8" IB	18" OB or 18 3/8" IB
	Min. Length	8"	8"	8"	8"	8"	8"	8"	8"
Prelude 3/4"	Min. Width	8"	10"	18"	24"	16"	16"	12"	16" OB or 16 1/2" IB
	Min. Length	12"	12"	12"	12"	12"	12"	12"	12"

Light Filtering	Price Group	Page		Cord Lock		Cord Loop		Cordless Ultra		Cordless Lift & Lock	
				Bottom Up	Top Down Bottom Up	Bottom Up	Top Down Bottom Up	Bottom Up	Top Down Bottom Up	Bottom Up	Top Down Bottom Up
Boutique 3/4"	1	17	Maximum Width & Length								
Debut	7 & 8	22									
Premiere	3	19									
Linen Weave 3/4"	1	17									
Symphony 3/8"	9	25	Refer to shaded area in price grids for max size (sq ft) by fabric style	108" width* 120" length	96" width 96" length	108" width 120" length	108" width 120" length	108" width* 84" length	96" width 84" length	96" width 84" length	96" width 84" length
Verona 3/4"	1	17									
Prelude 3/4"	11	27	Maximum Width & Length - Sq Ft.	120" width 120" length 50 sq ft	72" width 96" length 50 sq ft	120" width 120" length 100 sq ft	120" width 120" length 100 sq ft	120" width 84" length 70 sq ft	96" width 84" length 56 sq ft	84" width 84" length 49 sq ft	84" width 84" length 49 sq ft

Room Darkening & Blackout	Price Group	Page		Cord Lock		Cord Loop		Cordless Ultra		Cordless Lift & Lock	
				Bottom Up	Top Down Bottom Up	Bottom Up	Top Down Bottom Up	Bottom Up	Top Down Bottom Up	Bottom Up	Top Down Bottom Up
Boutique 3/4"	2	18	Maximum Width & Length								
Linen Weave 3/4"	2	18									
Premiere	4	20									
Verona 3/4"	2	18									
Symphony 3/8"	10	26	Refer to shaded area in price grids for max size (sq ft) by fabric style	120" width 120" length	84" width 96" length	120" width 120" length	120" width 120" length	Not Available		84" width 84" length	84" width 84" length
Prelude 3/4"***	12	28	Maximum Width & Length - Sq Ft.	120" width 120" length 50 sq ft	72" width 96" length 50 sq ft	120" width 120" length 100 sq ft	120" width 120" length 100 sq ft	120" width 84" length 70 sq ft	96" width 84" length 56 sq ft	84" width 84" length 49 sq ft	84" width 84" length 49 sq ft

Stacking Heights Information On Page More Information On Page	Cord Lock		Cord Loop		Cordless Ultra		Cordless Lift & Lock	
	Bottom Up	Top Down Bottom Up	Bottom Up	Top Down Bottom Up	Bottom Up	Top Down Bottom Up	Bottom Up	Top Down Bottom Up
	Page 15-16	Page 53	Page 15-16	Page 55	Page 15-16	Page 57	Page 15-16	Page 59

Please Note: For any shades under 12" width, the maximum height is 80".

* Baritone and Virtuoso maximum width is 120"

**Maximum width for sidemount refer to hardware pages.

Size Standards Comfortex Cellular and Pleated Shade Fabric Collections

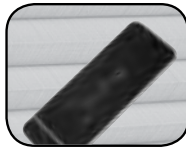

	Minimum	Motorization		Two-On-One Head Rail		
		Simplicity	Simplicity+ Rechargeable	PowerTouch Rechargeable	Cord Lock	Cord Loop/Cordless
ALL FABRICS (except 3/4" Prelude)	Minimum Width	18"		18"	16"	36"
	Min. Length	8"		8"	8"	8"
Prelude 3/4"	Min. Width	18"		-	16"	36"
	Min. Length	12"		-	12"	12"

Light Filtering	Price Group	Page		Motorization		Two-On-One Head Rail	
				Simplicity	Simplicity Rechargeable	PowerTouch Rechargeable	Cord Lock
Boutique 3/4"	1	17	Maximum Width & Length Refer to shaded area in price grids for max size (sq ft) by fabric style	96" width 120" length	96" width 120" length	144" width 120" length	144" width 120" length
Debut	7 & 8	22					
Premiere	3	19					
Linen Weave 3/4"	1	17					
Symphony 3/8"	9	25					
Verona 3/4"	1	17					
Prelude 3/4"	11	27	Maximum Width & Length - Sq Ft.	96" width 120" length 50 sq ft	NA	120" width 120" length 50 sq ft	120" width 120" length 50 sq ft

Room Darkening & Blackout	Price Group	Page		Motorization		Two-On-One Head Rail	
				Simplicity	Simplicity Rechargeable	PowerTouch Rechargeable	Cord Lock
Boutique 3/4"	2	18	Maximum Width & Length Refer to shaded area in price grids for max size (sq ft) by fabric style	96" width 120" length	96" width 120" length	144" width 120" length	144" width 120" length
Linen Weave 3/4"	2	18					
Premiere	4	20					
Verona 3/4"	2	18					
Symphony 3/8"	10	26					
Prelude 3/4"	12	28	Maximum Width & Length - Sq Ft.	96" width 120" length 50 sq ft	NA	120" width 120" length 50sq ft	120" width 120" length 50 sq ft

Stacking Heights Information On Page More Information On Page	Motorization		Two-On-One Head Rail		
	Simplicity	Simplicity Rechargeable	PowerTouch Rechargeable	Cord Lock	Cord Loop/Cordless
	Page 15-16 Page 61		Page 15-16 Page 69	Page 15-16 Page 13	

Please Note: For any shades under 12" width, the maximum height is 80". * Maximum widths and lengths listed do not take into account square foot or weight limitations. Make sure to refer to shaded areas on price groups for maximum size availability by fabric style.

+Simplicity Rechargeable Top Down-Bottom Up motorization minimum width is 24" IB and 23 3/8" OB.

Comfortex Cellular and Pleated Shade Fabric Collections Size Standards

Cellular Shade Collection

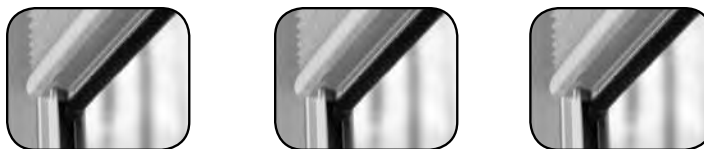

		SlumberShade Cord Lock		SlumberShade Cord Loop		SlumberShade Cordless	
		Bottom Up	Top Down Bottom Up	Bottom Up	Top Down Bottom Up	Bottom Up	Top Down Bottom Up
ALL FABRICS	Minimum Width	9"	13"	15"	25"	16" IB	19"
	Min. Length	8"	8"	8"	8"	8"	8"

			SlumberShade Cord Lock		SlumberShade Cord Loop		SlumberShade Cordless	
			Bottom Up	Top Down Bottom Up	Bottom Up	Top Down Bottom Up	Bottom Up	Top Down Bottom Up
Light Filtering	Price Group	Page						
Debut	7	23	Maximum Width & Length					
Linen Weave	1	17						
Premiere	3	19						
Symphony 3/8"	9	25						
Verona	1	17	Refer to shaded area in price grids for max size (sq ft) by fabric style		96" width 120" length	96" width 96" length	96" width 120" length	96" width 120" length

			SlumberShade Cord Lock		SlumberShade Cord Loop		SlumberShade Cordless	
			Bottom Up	Top Down Bottom Up	Bottom Up	Top Down Bottom Up	Bottom Up	Top Down Bottom Up
Room Darkening & Blackout	Price Group	Page						
Debut	8	24	Maximum Width & Length					
Linen Weave	2	18						
Premiere	4	20						
Symphony 3/8"	10	26						
Verona	2	18	Refer to shaded area in price grids for max size (sq ft) by fabric style		96" width 120" length	84" width 96" length	96" width 120" length	96" width 120" length
							Symphony Blackout not available as cordless	

			SlumberShade Cord Lock		SlumberShade Cord Loop		SlumberShade Cordless	
			Bottom Up	Top Down Bottom Up	Bottom Up	Top Down Bottom Up	Bottom Up	Top Down Bottom Up
Stacking Heights Information On Page More Information On Page			Page 15-16 Page 73		Page 15-16 Page 73		Page 15-16 Page 731	

Please Note: For any shades under 12" width, the maximum height is 80".

Product Options Availability

Use this table to ensure your coordinating options and unique shapes are consistent with your product selections.

STANDARD CORD LOCK	Verona	Boutique	Premiere Light Filtering	Premiere Blackout	Linen Weave LF & RD	Symphony Light Filtering	Symphony Blackout
Standard Cord Lock	•	•	•	•	•	•	•
Top Down-Bottom Up	•	•	•	•	•	•	•
Two-On-One Head Rail	•	•	•	•	•	•	•
Day-Night	•	•	•	•	•	•	•

CORD LOOP	Verona	Boutique	Premiere Light Filtering	Premiere Blackout	Linen Weave LF & RD	Symphony Light Filtering	Symphony Blackout
Cord Loop	•	•	•	•	•	•	•
Cord Loop Top Down-Bottom Up	•	•	•	•	•	•	•
Cord Loop Two-On-One Head Rail	•	•	•	•	•	•	•

CORDLESS ULTRA	Verona	Boutique	Premiere Light Filtering	Premiere Blackout	Linen Weave LF & RD	Symphony Light Filtering	Symphony Blackout
Cordless Ultra	•	•	•	•	•	•	-
Cordless Ultra Top Down-Bottom Up	•	•	•	•	•	•	-

CORDLESS LIFT & LOCK	Verona	Boutique	Premiere Light Filtering	Premiere Blackout	Linen Weave LF & RD	Symphony Light Filtering	Symphony Blackout
Cordless Lift & Lock	•	•	•	•	•	•	•
Cordless Lift & Lock Top Down-Bottom Up	•	•	•	•	•	•	•

MOTORIZATION	Verona	Boutique	Premiere Light Filtering	Premiere Blackout	Linen Weave LF & RD	Symphony Light Filtering	Symphony Blackout
Simplicity Motorization	•	•	•	•	•	•	•
Simplicity Rechargeable Motorization	•	•	•	•	•	•	•
PowerTouch™ Rechargeable	•	•	•	•	•	•	•
Top Down-Bottom Up	•	•	•	•	•	•	•

INSULATING SLUMBERSHADES	Verona	Boutique	Premiere Light Filtering	Premiere Blackout	Linen Weave LF & RD	Symphony Light Filtering	Symphony Blackout
Cord Lock	•	-	•	•	•	•	•
Cord Lock Top Down-Bottom Up	•	-	•	•	•	•	•
Cordless Ultra	•	-	•	•	•	•	-
Cordless Ultra Top Down-Bottom Up	•	-	•	•	•	•	-
Cord Loop	•	-	•	•	•	•	•
Cord Loop Top Down-Bottom Up	•	-	•	•	•	•	•

SKYLIGHTS AND SPECIALTY SHAPES	Verona	Boutique	Premiere Light Filtering	Premiere Blackout	Linen Weave LF & RD	Symphony Light Filtering	Symphony Blackout
Balcony Shading System	-	-	-	-	-	•	•
French Door Decor	•	•	•	•	•	•	•
Mezzo Motorized Skylights	•	•	•	•	•	•	•
Octagon	•	•	•	•	•	•	•
Ovation Cellular Slider	•	•	•++	•++	•	•	-
Quarter Round - Moveable	•	•	•	•	•	•	•
Quarter Round - Non-Movable	•	•	•	•	•	•	•
Soprano Skylights and Greenhouses	-	-	-	-	-	•	-
Starburst Arch - Movable	•	•	•	•	•	•	•
Starburst Arch - Non-Movable	•	•	•	•	•	•	•
Sunset Arch - Moveable	•*	•*	•	•	•*	•	-
Trapezoid	•	•	•	•	•	•	•

* Light Filtering Fabric Only
+ Light filtering perfect half circles only

++ 3/4" Premiere fabrics only

Product Options Availability

Use this table to ensure your coordinating options and unique shapes are consistent with your product selections.

STANDARD CORD LOCK	Debut ½" Light Filtering	Debut ¾" Light Filtering	Debut Double Cell Light Filtering
Standard Cord Lock	•	•	•
Top Down-Bottom Up	•	•	•
Two-On-One Head Rail	•	•	•
Day-Night	•	•	•

CORD LOOP			
Cord Loop	•	•	•
Cord Loop Top Down-Bottom Up	•	•	•
Cord Loop Two-On-One Head Rail	•	•	•

CORDLESS ULTRA			
Cordless Ultra	•	•	•
Cordless Ultra Top Down-Bottom Up	•	•	•

CORDLESS LIFT & LOCK			
Cordless Lift & Lock	•	•	•
Cordless Lift & Lock Top Down-Bottom Up	•	•	•

MOTORIZATION			
Simplicity Motorization	•	•	•
Simplicity Rechargeable Motorization	•	•	•
PowerTouch™ Rechargeable	•	•	•

INSULATING SLUMBERSHADES			
Cord Lock	•	•	•
Cord Lock Top Down-Bottom Up	•	•	•
Cordless Ultra	•	•	•
Cordless Ultra Top Down-Bottom Up	•	•	•
Cord Loop	•	•	•
Cord Loop Top Down-Bottom Up	•	•	•

SKYLIGHTS AND SPECIALTY SHAPES			
Balcony Shading System	•	-	-
French Door Decor	•	•	•
Mezzo Motorized Skylights	•	•	•
Octagon	•	•	•
Ovation Cellular Slider	•	•	•
Quarter Round - Moveable	•	•	•
Quarter Round - Non-Movable	•	•	•
Soprano Skylights and Greenhouses	•	-	-
Starburst Arch - Movable	•	•	•
Starburst Arch - Non-Movable	•	•	•
Sunset Arch - Moveable	•	•	•
Trapezoid	•	•	•

* Light Filtering Fabric Only
+ Light filtering perfect half circles only

** 1/2" Premiere fabrics only
++ 3/4" Premiere fabrics only

Shade Stack Heights

Measurements are in inches. Shade stacking heights applicable when the shade is in the fully raised position.

RECTANGULAR CORD LOCK - Includes head and bottom rails	48"	72"	84"	96"	108"	120"
Verona	2"	2 ³ / ₈ "	2 ⁵ / ₈ "	2 ⁷ / ₈ "	3 ¹ / ₈ "	3 ³ / ₈ "
Boutique	2"	2 ³ / ₈ "	2 ⁵ / ₈ "	2 ⁷ / ₈ "	3 ¹ / ₈ "	3 ³ / ₈ "
Debut 1/2" Double Cell Light Filtering	1 1/2"	1 5/8"	1 3/4"	1 7/8"	2	2 1/8"
Debut 1/2" Single Cell Light Filtering	3 1/4"	2 3/4"	3"	3 3/8"	3 3/8"	4
Debut 3/4" Single Cell Light Filtering	1 1/2"	1 5/8"	1 3/4"	1 7/8"	2	2 1/8"
Linen Weave (All)	2"	2 ³ / ₈ "	2 ⁵ / ₈ "	2 ⁷ / ₈ "	3 ¹ / ₈ "	3 ³ / ₈ "
Premiere 1/2" Single Cell Blackout	2"	2 1/2"	2 3/8"	2 7/8"	3 1/8"	3 1/4"
Premiere 1/2" Single Cell Light Filtering	1 7/8"	2 1/4"	2 1/2"	2 5/8"	2 7/8"	3
Premiere 3/4" Single Cell Blackout	2"	2 3/8"	2 5/8"	2 3/4"	3	3 3/8"
Premiere 3/4" Single Cell Light Filtering	1 3/4"	2 1/8"	2 1/4"	2 3/8"	2 1/2"	2 5/8"
Symphony 3/8" Double Cell Blackout	2"	2 1/2"	2 3/4"	3"	3 1/4"	3 1/2"
Symphony 3/8" Double Cell Light Filtering	2 1/4"	2 3/4"	3"	3 1/4"	3 1/2"	3 3/4"

For Top Down-Bottom Up, add 3/8"

CORD LOOP - CORDLESS ULTRA - MOTORIZATION - Includes head and bottom rails	48"	72"	84"	96"	108"	120"
Verona	3"	3 3/8"	3 5/8"	3 7/8"	4 1/8"	4 3/8"
Boutique	3"	3 3/8"	3 5/8"	3 7/8"	4 1/8"	4 3/8"
Debut 1/2" Double Cell Light Filtering	2 1/2"	2 5/8"	2 3/4"	2 7/8"	3	3 3/8"
Debut 1/2" Single Cell Light Filtering	3 1/4"	3 3/4"	4"	4 3/8"	4 5/8"	5
Debut 3/4" Single Cell Light Filtering	2 1/2"	2 5/8"	2 3/4"	2 7/8"	3	3 3/8"
Linen Weave (All)	3"	3 3/8"	3 5/8"	3 7/8"	4 1/8"	4 3/8"
Premiere 1/2" Single Cell Blackout	3"	3 1/2"	3 5/8"	3 7/8"	4 1/8"	4 1/4"
Premiere 1/2" Single Cell Light Filtering	2 7/8"	3 1/4"	3 1/2"	3 3/8"	3 7/8"	4
Premiere 3/4" Single Cell Blackout	3"	3 3/8"	3 5/8"	3 3/4"	4	4 1/8"
Premiere 3/4" Single Cell Light Filtering	2 3/4"	3 1/8"	3 1/4"	3 3/8"	3 1/2"	3 5/8"
Symphony 3/8" Double Cell Blackout	2 7/8"	3 3/8"	3 5/8"	3 7/8"	4 1/2"	4 3/4"
Symphony 3/8" Double Cell Light Filtering	3 1/8"	3 1/2"	3 3/4"	3 7/8"	4 1/8"	4 1/4"

For Top Down-Bottom Up, add 3/8"

CORDLESS LIFT & LOCK - Includes head and bottom rails	48"	60"	72"	84"	108"	120"
Verona	2 3/4"	3 1/8"	3 3/8"	3 5/8"	3 7/8"	4 1/8"
Boutique	2 3/4"	3 1/8"	3 3/8"	3 5/8"	3 7/8"	4 1/8"
Debut 1/2" Double Cell Light Filtering	2 1/4"	2 3/8"	2 1/2"	2 5/8"	2 3/4"	2 7/8"
Debut 1/2" Single Cell Light Filtering	3"	3 1/2"	3 3/4"	4 1/8"	4 3/8"	4 3/4"
Debut 3/4" Single Cell Light Filtering	2 1/4"	2 3/8"	2 1/2"	2 5/8"	2 3/4"	2 7/8"
Linen Weave (All)	2 3/4"	3 1/8"	3 3/8"	3 5/8"	3 7/8"	4 1/8"
Premiere 1/2" Single Cell Blackout	2 3/4"	3 1/4"	3 3/8"	3 5/8"	3 7/8"	4
Premiere 1/2" Single Cell Light Filtering	2 5/8"	3 3/4"	3 1/4"	3 3/8"	3 1/2"	3 1/2"
Premiere 3/4" Single Cell Blackout	2 3/4"	3 1/8"	3 3/8"	3 1/2"	3 3/4"	3 7/8"
Premiere 3/4" Single Cell Light Filtering	2 1/4"	2 7/8"	3"	3 1/8"	3 3/8"	3 1/2"
Symphony 3/8" Double Cell Blackout	2 3/4"	3 1/4"	3 1/2"	NA	NA	NA
Symphony 3/8" Double Cell Light Filtering	3"	3 1/2"	3 3/4"	4"	4 1/4"	4 1/2"

For Top Down-Bottom Up, add 1 1/4"

OVATION	84"	96"	108"	120"
All Fabrics	6 1/2"	7 1/4"	8"	8 3/4"

Ovations minimum fabric stack measures 6 1/2" regardless of the ordered width. Fabric stacking dimensions are determined by the slider's hardware, not ordered width.

Prelude Shade Stack Heights

Measurements are in inches. Shade stacking heights applicable when the shade is in the fully raised position.

RECTANGULAR CORD LOCK - Includes head and bottom rails	48"	72"	84"	96"	108"	120"
Prelude Light Filtering	2"	2 ³ / ₈ "	2 ⁵ / ₈ "	2 ⁷ / ₈ "	3 ¹ / ₈ "	3 ³ / ₈ "
Prelude Blackout	1 ¹ / ₂ "	1 ³ / ₄ "	1 ⁷ / ₈ "	2"	2 ¹ / ₈ "	2 ¹ / ₄ "

For Top Down-Bottom Up, add ⁵/₈"

CORD LOOP - CORDLESS ULTRA - MOTORIZATION - Includes head and bottom rails	48"	72"	84"	96"	108"	120"
Prelude Light Filtering	3"	3 ³ / ₈ "	3 ⁵ / ₈ "	3 ⁷ / ₈ "	4 ¹ / ₈ "	4 ³ / ₈ "
Prelude Blackout	2 ¹ / ₄ "	2 ¹ / ₂ "	2 ⁵ / ₈ "	2 ³ / ₄ "	2 ⁷ / ₈ "	3

For Top Down-Bottom Up, add ⁵/₈"

CORDLESS LIFT & LOCK - Includes head and bottom rails	48"	60"	72"	84"	108"	120"
Prelude Light Filtering	2 ³ / ₄ "	3 ¹ / ₈ "	3 ³ / ₈ "	3 ⁵ / ₈ "	3 ⁷ / ₈ "	4 ¹ / ₈ "
Prelude Blackout	2 ¹ / ₄ "	2 ¹ / ₂ "	2 ⁵ / ₈ "	2 ³ / ₄ "	2 ⁷ / ₈ "	3

For Top Down-Bottom Up, add 1¹/₄"

OVATION	84"	96"	108"	120"
Prelude	6 ¹ / ₂ "	7 ¹ / ₄ "	8"	8 ³ / ₄ "

Ovations minimum fabric stack measures 6¹/₂" regardless of the ordered width. Fabric stacking dimensions are determined by the slider's hardware, not ordered width.



**Boutique 3/4" Light Filtering
Linen Weave 3/4" Light Filtering
Verona 3/4" Light Filtering**

**PRICE GROUP 1
Cord Lock
Cordless Lift & Lock**

Standard Rectangular

		Width In Inches														
		24	30	36	42	48	54	60	66	72	84	96	108	120	132	144
Length In Inches	36	189	211	242	270	299	325	353	377	405	466	524	582	644	702	761
	42	202	232	260	294	325	355	388	417	448	515	580	646	715	782	844
	48	214	248	284	318	353	386	420	457	491	563	635	708	784	856	929
	54	230	263	302	340	379	416	453	493	533	610	692	770	853	935	1013
	60	244	282	325	364	404	447	487	531	574	656	743	831	918	1007	1096
	66	256	299	345	388	432	477	521	567	613	705	801	895	991	1082	1178
	72	270	313	364	414	460	509	558	606	653	752	856	957	1061	1160	1263
	78	284	334	383	431	488	536	589	643	695	800	911	1018	1126	1236	1341
	84	293	346	402	457	512	563	620	675	730	841	959	1070	1190	1301	1418
	90	306	362	420	477	537	595	652	711	775	892	1012	1132	1254	1377	1498
	96	318	377	441	499	561	622	684	745	807	933	1062	1188	1320	1442	1571
	108	346	408	477	542	614	678	748	815	886	1022	1163	1301	1445	1586	1725
120	370	442	517	589	669	739	813	890	961	1113	1267	1420	1572	1728	1879	

 Cord Loop Hardware is recommended on sizes within the shaded area.
Motorized Lift Systems are not offered within the shaded area.

Widths over 108" will be built as Two-On-One Shades.

LIFT SYSTEM AND DESIGN UPGRADES		ADD	
Cord Lock	Top Down-Bottom Up	\$64	
Cordless Lift & Lock	Bottom Up	No Charge	
	Top Down-Bottom Up	\$83	
Cordless Ultra	Bottom Up	\$83	
	Top Down-Bottom Up	\$166	
Cord Loop	Bottom Up	\$83	
	Top Down-Bottom Up	\$166	
DESIGNER UPGRADE OPTIONS (Add to any Lift System Upgrade Above)		ADD	
Metallic Hardware or Fabric Wrapped Hardware		\$22	
Scotchgard Stain Protection		\$35	
MOTORIZATION*		MORE INFO	ADD
PowerTouch Rechargeable		Pg 69	\$110
Simplicity - Motor and Battery Wand		Pg 61	\$334
Simplicity Rechargeable Motorization - Motor with Integrated Battery		Pg 63	\$334
Plug-In Charger for Li-Lon Battery Pack (used for PowerTouch and Simplicity Rechargeable and is required)		Pg 65	\$27
Simplicity 5 Channel Remote		Pg 65	\$40
Simplicity 6 Channel Remote with Timer		Pg 65	\$65
Simplicity Smart Controller (NEO)		Pg 68	\$330
Top Down-Bottom Up Motorization and Solar Charge Option Pricing		Pg 9	
ADDITIONAL OPTIONS			
Insulating SlumberShades		\$134 (Not Available with Boutique fabric)	
Two-On-One Head Rail		\$50 Add to Cord Lock Shade and add lift system upgrade for cordloop or cordless	
Cut Outs		\$52 Per side	
Day-Night		Price each panel as separate shade and add together	
Highlights Cornice Valance		See Page 118 For More Information	

*Motorized Pricing Examples pages 8, 62, 64 and 67

Boutique 3/4" Room Darkening
Linen Weave 3/4" Room Darkening
Verona 3/4" Room Darkening

PRICE GROUP 2
Cord Lock
Cordless Lift & Lock

Standard Rectangular

		Width In Inches														
		24	30	36	42	48	54	60	66	72	84	96	108	120	132	144
Length In Inches	36	246	274	315	351	389	423	459	490	527	606	681	757	837	913	989
	42	263	302	338	382	423	462	504	542	582	670	754	840	930	1017	1097
	48	278	322	369	413	459	502	546	594	638	732	826	920	1019	1113	1208
	54	299	342	393	442	493	541	589	641	693	793	900	1001	1109	1216	1317
	60	317	367	423	473	525	581	633	690	746	853	966	1080	1193	1309	1425
	66	333	389	449	504	562	620	677	737	797	917	1041	1164	1288	1407	1531
	72	351	407	473	538	598	662	725	788	849	978	1113	1244	1379	1508	1642
	78	369	434	498	560	634	697	766	836	904	1040	1184	1323	1464	1607	1743
	84	381	450	523	594	666	732	806	878	949	1093	1247	1391	1547	1691	1843
	90	398	471	546	620	698	774	848	924	1008	1160	1316	1472	1630	1790	1947
96	413	490	573	649	729	809	889	969	1049	1213	1381	1544	1716	1875	2042	
108	450	530	620	705	798	881	972	1060	1152	1329	1512	1691	1879	2062	2243	
120	481	575	672	766	870	961	1057	1157	1249	1447	1647	1846	2044	2246	2443	

■ Cord Loop Hardware is recommended on sizes within the shaded area.
 Motorized Lift Systems are not offered within the shaded area.

Widths over 108" will be built as Two-On-One Shades.

LIFT SYSTEM AND DESIGN UPGRADES			ADD	
Cord Lock	Top Down-Bottom Up		\$64	
Cordless Lift & Lock	Bottom Up		No Charge	
	Top Down-Bottom Up		\$83	
Cordless Ultra	Bottom Up		\$83	
	Top Down-Bottom Up		\$166	
Cord Loop	Bottom Up		\$83	
	Top Down-Bottom Up		\$166	
DESIGNER UPGRADE OPTIONS (Add to any Lift System Upgrade Above)			ADD	
Metallic Hardware or Fabric Wrapped Hardware			\$22	
Scotchgard Stain Protection			\$35	
MOTORIZATION*			MORE INFO	ADD
PowerTouch Rechargeable			Pg 69	\$110
Simplicity - Motor and Battery Wand			Pg 61	\$334
Simplicity Rechargeable Motorization - Motor with Integrated Battery			Pg 63	\$334
Plug-In Charger for Li-Ion Battery Pack (used for PowerTouch and Simplicity Rechargeable and is required)			Pg 65	\$27
Simplicity 5 Channel Remote			Pg 65	\$40
Simplicity 6 Channel Remote with Timer			Pg 65	\$65
Simplicity Smart Controller (NEO)			Pg 68	\$330
Top Down-Bottom Up Motorization and Solar Charge Option Pricing			Pg 9	
ADDITIONAL OPTIONS				
Insulating SlumberShades		\$134 (Not Available with Boutique fabric)		
Two-On-One Head Rail		\$50 Add to Cord Lock Shade and add lift system upgrade for cordloop or cordless		
Cut Outs		\$52 Per side		
Day-Night		Price each panel as separate shade and add together		
Highlights Cornice Valance		See Page 118 For More Information		

*Motorized Pricing Examples pages 8, 62, 64 and 67

Premiere 1/2" Light Filtering

PRICE GROUP 3
Cord Lock
Cordless Lift & Lock

Standard Rectangular

		Width In Inches														
		24	30	36	42	48	54	60	66	72	84	96	108	120	132	144
Length In Inches	36	140	157	180	201	222	241	262	280	301	346	389	432	478	521	565
	42	150	172	193	218	241	263	288	310	333	382	431	479	531	580	626
	48	159	184	211	236	262	286	312	339	365	417	471	525	581	635	689
	54	171	195	224	252	281	308	336	366	395	453	513	571	633	693	752
	60	181	209	241	270	300	332	361	394	426	487	552	616	681	747	813
	66	190	222	256	288	321	354	387	421	455	523	594	664	735	802	874
	72	201	233	270	307	341	378	414	449	484	558	635	710	787	861	937
	78	211	248	284	319	362	398	437	477	515	593	676	755	835	917	995
	84	217	257	299	339	380	417	460	501	542	624	711	794	883	965	1052
	90	227	269	312	354	399	442	483	527	575	662	751	840	930	1021	1111
	96	236	280	327	370	416	461	508	553	599	692	788	882	979	1070	1165
108	257	303	354	402	456	503	555	604	657	758	863	965	1072	1176	1280	
120	274	328	383	437	497	548	603	660	713	825	940	1053	1166	1282	1394	

 Cord Loop Hardware is recommended on sizes within the shaded area.
Motorized Lift Systems are not offered within the shaded area.

Widths over 108" will be built as Two-On-One Shades.

LIFT SYSTEM AND DESIGN UPGRADES		ADD	
Cord Lock	Top Down-Bottom Up	\$64	
Cordless Lift & Lock	Bottom Up	No Charge	
	Top Down-Bottom Up	\$83	
Cordless Ultra	Bottom Up	\$83	
	Top Down-Bottom Up	\$166	
Cord Loop	Bottom Up	\$83	
	Top Down-Bottom Up	\$166	
DESIGNER UPGRADE OPTIONS (Add to any Lift System Upgrade Above)		ADD	
Metallic Hardware or Fabric Wrapped Hardware		\$22	
Scotchgard Stain Protection		\$35	
MOTORIZATION*		MORE INFO	ADD
PowerTouch Rechargeable		Pg 69	\$110
Simplicity - Motor and Battery Wand		Pg 61	\$334
Simplicity Rechargeable Motorization - Motor with Integrated Battery		Pg 63	\$334
Plug-In Charger for Li-Lon Battery Pack (used for PowerTouch and Simplicity Rechargeable and is required)		Pg 65	\$27
Simplicity 5 Channel Remote		Pg 65	\$40
Simplicity 6 Channel Remote with Timer		Pg 65	\$65
Simplicity Smart Controller (NEO)		Pg 68	\$330
Top Down-Bottom Up Motorization and Solar Charge Option Pricing		Pg 9	
ADDITIONAL OPTIONS			
Insulating SlumberShades		\$134 See Page 73 For More Information	
Two-On-One Head Rail		\$50 Add to Cord Lock Shade and add lift system upgrade for cordloop or cordless	
Cut Outs		\$52 Per side	
Day-Night		Price each panel as separate shade and add together	
Highlights Cornice Valance		See Page 118 For More Information	
Prints & Custom Graphics		Add 20% - Includes Anna Cote, Gradients, Spheres, Tuscan Scroll and Custom Graphics	

*Motorized Pricing Examples pages 8, 62, 64 and 67

Premiere 1/2" Blackout

PRICE GROUP 4
Cord Lock
Cordless Lift & Lock

Standard Rectangular

		Width In Inches														
		24	30	36	42	48	54	60	66	72	84	96	108	120	132	144
Length In Inches	36	182	205	234	262	289	314	341	364	392	450	506	562	622	678	735
	42	195	224	251	284	314	342	375	403	433	497	561	623	691	754	814
	48	207	240	275	307	341	372	406	441	475	543	613	683	756	826	896
	54	223	254	292	328	366	401	437	476	514	589	667	743	823	901	978
	60	236	272	314	351	390	432	470	513	554	634	718	801	886	972	1057
	66	247	289	333	375	418	461	504	548	592	680	773	864	956	1043	1137
	72	262	303	351	400	444	492	539	584	630	726	826	923	1024	1120	1219
	78	275	323	370	415	471	518	569	621	670	771	879	982	1086	1193	1294
	84	283	335	389	441	494	543	598	652	705	812	925	1033	1148	1255	1368
	90	296	350	406	461	519	575	628	686	748	861	977	1092	1209	1328	1445
	96	307	364	426	481	541	600	661	719	779	900	1025	1147	1273	1391	1515
	108	335	394	461	523	593	654	722	786	855	986	1122	1255	1394	1529	1664
120	357	427	498	569	647	713	784	858	927	1073	1222	1369	1516	1667	1813	

 Cord Loop Hardware is recommended on sizes within the shaded area. Motorized Lift Systems are not offered within the shaded area.

Widths over 108" will be built as Two-On-One Shades.

LIFT SYSTEM AND DESIGN UPGRADES		ADD	
Cord Lock	Top Down-Bottom Up	\$64	
Cordless Lift & Lock	Bottom Up	No Charge	
	Top Down-Bottom Up	\$83	
Cordless Ultra	Bottom Up	\$83	
	Top Down-Bottom Up	\$166	
Cord Loop	Bottom Up	\$83	
	Top Down-Bottom Up	\$166	
DESIGNER UPGRADE OPTIONS (Add to any Lift System Upgrade Above)		ADD	
Metallic Hardware or Fabric Wrapped Hardware		\$22	
Scotchgard Stain Protection		\$35	
MOTORIZATION*		MORE INFO	ADD
PowerTouch Rechargeable		Pg 69	\$110
Simplicity - Motor and Battery Wand		Pg 61	\$334
Simplicity Rechargeable Motorization - Motor with Integrated Battery		Pg 63	\$334
Plug-In Charger for Li-Lon Battery Pack (used for PowerTouch and Simplicity Rechargeable and is required)		Pg 65	\$27
Simplicity 5 Channel Remote		Pg 65	\$40
Simplicity 6 Channel Remote with Timer		Pg 65	\$65
Simplicity Smart Controller (NEO)		Pg 68	\$330
Top Down-Bottom Up Motorization and Solar Charge Option Pricing		Pg 9	
ADDITIONAL OPTIONS			
Insulating SlumberShades		\$134 See Page 73 For More Information	
Two-On-One Head Rail		\$50 Add to Cord Lock Shade and add lift system upgrade for cordloop or cordless	
Cut Outs		\$52 Per side	
Day-Night		Price each panel as separate shade and add together	
Highlights Cornice Valance		See Page 118 For More Information	
Prints & Custom Graphics		Add 20% - Includes Anna Cote, Gradients, Spheres, Tuscan Scroll, Homespun, Florance, Strata, Blossom, Country Woven and Custom Graphics	

*Motorized Pricing Examples pages 8, 62, 64 and 67

Premiere 3/4" Light Filtering

PRICE GROUP 5
Cord Lock
Cordless Lift & Lock

Standard Rectangular

		Width In Inches														
		24	30	36	42	48	54	60	66	72	84	96	108	120	132	144
Length In Inches	36	154	173	198	222	245	266	289	308	332	381	428	476	526	574	622
	42	165	190	213	240	266	290	317	341	367	421	475	527	585	638	689
	48	175	203	233	260	289	315	344	373	402	459	519	578	640	699	758
	54	189	215	247	278	310	339	370	403	435	499	565	629	697	763	828
	60	200	230	266	297	330	366	398	434	469	536	608	678	750	822	895
	66	209	245	282	317	354	390	426	464	501	576	654	731	809	883	962
	72	222	257	297	338	376	416	456	494	533	614	699	781	866	948	1031
	78	233	273	313	351	399	438	481	525	567	653	744	831	919	1009	1095
	84	239	283	329	373	418	459	506	552	597	687	783	874	972	1062	1158
	90	250	296	344	390	439	487	532	580	633	729	827	924	1023	1124	1223
	96	260	308	360	407	458	508	559	609	659	762	867	971	1077	1177	1282
	108	283	334	390	443	502	554	611	665	723	834	950	1062	1180	1294	1408
120	302	361	422	481	547	603	664	726	785	908	1034	1159	1283	1411	1534	

 Cord Loop Hardware is recommended on sizes within the shaded area. Motorized Lift Systems are not offered within the shaded area.

Widths over 108" will be built as Two-On-One Shades.

LIFT SYSTEM AND DESIGN UPGRADES		ADD	
Cord Lock	Top Down-Bottom Up	\$64	
Cordless Lift & Lock	Bottom Up	No Charge	
	Top Down-Bottom Up	\$83	
Cordless Ultra	Bottom Up	\$83	
	Top Down-Bottom Up	\$166	
Cord Loop	Bottom Up	\$83	
	Top Down-Bottom Up	\$166	
DESIGNER UPGRADE OPTIONS (Add to any Lift System Upgrade Above)		ADD	
Metallic Hardware or Fabric Wrapped Hardware		\$22	
Scotchgard Stain Protection		\$35	
MOTORIZATION*		MORE INFO	ADD
PowerTouch Rechargeable		Pg 69	\$110
Simplicity - Motor and Battery Wand		Pg 61	\$334
Simplicity Rechargeable Motorization - Motor with Integrated Battery		Pg 63	\$334
Plug-In Charger for Li-Lon Battery Pack (used for PowerTouch and Simplicity Rechargeable and is required)		Pg 65	\$27
Simplicity 5 Channel Remote		Pg 65	\$40
Simplicity 6 Channel Remote with Timer		Pg 65	\$65
Simplicity Smart Controller (NEO)		Pg 68	\$330
Top Down-Bottom Up Motorization and Solar Charge Option Pricing		Pg 9	
ADDITIONAL OPTIONS			
Insulating SlumberShades		\$134 See Page 73 For More Information	
Two-On-One Head Rail		\$50 Add to Cord Lock Shade and add lift system upgrade for cordloop or cordless	
Cut Outs		\$52 Per side	
Day-Night		Price each panel as separate shade and add together	
Highlights Cornice Valance		See Page 118 For More Information	
Prints & Custom Graphics		Add 20% - Includes Anna Cote, Gradients, Spheres, Tuscan Scroll and Custom Graphics	

*Motorized Pricing Examples pages 8, 62, 64 and 67

Premiere 3/4" Blackout

PRICE GROUP 6
Cord Lock
Cordless Lift & Lock

Standard Rectangular

		Width In Inches														
		24	30	36	42	48	54	60	66	72	84	96	108	120	132	144
Length In Inches	36	201	225	258	289	319	346	376	401	432	496	557	619	684	747	809
	42	215	247	277	312	346	377	413	444	478	548	618	686	761	830	896
	48	228	264	303	338	376	410	448	485	523	597	675	752	832	909	986
	54	246	280	322	362	403	441	481	524	566	649	735	818	907	992	1077
	60	260	299	346	387	429	476	518	565	610	697	791	882	975	1069	1164
	66	272	319	367	413	461	507	554	604	652	749	851	951	1052	1148	1251
	72	289	335	387	440	489	541	593	643	693	799	909	1016	1126	1233	1341
	78	303	355	407	457	519	570	626	683	738	849	968	1081	1195	1312	1424
	84	311	368	428	485	544	597	658	718	777	894	1018	1137	1264	1381	1506
	90	325	385	448	507	571	634	692	754	823	948	1076	1202	1330	1462	1590
96	338	401	468	530	596	661	727	792	857	991	1128	1263	1401	1531	1667	
108	368	435	507	576	653	721	795	865	940	1085	1235	1381	1534	1683	1831	
120	393	470	549	626	712	784	864	944	1021	1181	1345	1507	1668	1835	1995	

 Cord Loop Hardware is recommended on sizes within the shaded area. Motorized Lift Systems are not offered within the shaded area.

Widths over 108" will be built as Two-On-One Shades.

LIFT SYSTEM AND DESIGN UPGRADES			ADD
Cord Lock	Top Down-Bottom Up		\$64
Cordless Lift & Lock	Bottom Up		No Charge
	Top Down-Bottom Up		\$83
Cordless Ultra	Bottom Up		\$83
	Top Down-Bottom Up		\$166
Cord Loop	Bottom Up		\$83
	Top Down-Bottom Up		\$166
DESIGNER UPGRADE OPTIONS (Add to any Lift System Upgrade Above)			ADD
Metallic Hardware or Fabric Wrapped Hardware			\$22
Scotchgard Stain Protection			\$35
MOTORIZATION*			MORE INFO
PowerTouch Rechargeable			Pg 69
Simplicity - Motor and Battery Wand			Pg 61
Simplicity Rechargeable Motorization - Motor with Integrated Battery			Pg 63
Plug-In Charger for Li-Ion Battery Pack (used for PowerTouch and Simplicity Rechargeable and is required)			Pg 65
Simplicity 5 Channel Remote			Pg 65
Simplicity 6 Channel Remote with Timer			Pg 65
Simplicity Smart Controller (NEO)			Pg 68
Top Down-Bottom Up Motorization and Solar Charge Option Pricing			Pg 9
ADDITIONAL OPTIONS			
Insulating SlumberShades		\$134 See Page 73 For More Information	
Two-On-One Head Rail		\$50 Add to Cord Lock Shade and add lift system upgrade for cordloop or cordless	
Cut Outs		\$52 Per side	
Day-Night		Price each panel as separate shade and add together	
Highlights Cornice Valance		See Page 118 For More Information	
Prints & Custom Graphics		Add 20% - Includes Anna Cote, Gradients, Spheres, Tuscan Scroll, Homespun, Florence, Strata, Blossom, Country Woven and Custom Graphics	

*Motorized Pricing Examples pages 8, 62, 64 and 67

Debut 1/2" Single Cell

PRICE GROUP 7
Cord Lock
Cordless Lift & Lock

Standard Rectangular

		Width In Inches														
		24	30	36	42	48	54	60	66	72	84	96	108	120	132	144
Length In Inches	36	134	150	172	192	212	230	250	267	287	330	371	412	456	497	539
	42	143	164	184	208	230	251	275	296	318	365	411	457	507	554	598
	48	152	176	201	225	250	273	298	324	348	398	450	501	555	606	658
	54	163	186	214	241	268	294	321	349	377	432	490	545	604	662	718
	60	173	200	230	258	286	317	345	376	407	465	527	588	650	713	776
	66	181	212	244	275	306	338	369	402	434	499	567	634	702	766	834
	72	192	222	258	293	326	361	395	429	462	533	606	678	751	822	894
	78	201	237	271	305	346	380	417	455	492	566	645	721	797	875	950
	84	207	245	285	324	363	398	439	478	517	596	679	758	843	921	1004
	90	217	257	298	338	381	422	461	503	549	632	717	802	888	975	1061
	96	225	267	312	353	397	440	485	528	572	661	752	842	935	1021	1112
108	245	289	338	384	435	480	530	577	627	724	824	921	1023	1123	1222	
120	262	313	366	417	474	523	576	630	681	788	897	1005	1113	1224	1331	

Widths over 108" will be built as Two-On-One Shades.

LIFT SYSTEM AND DESIGN UPGRADES			ADD
Cord Lock	Top Down-Bottom Up		\$64
Cordless Lift & Lock	Bottom Up		No Charge
	Top Down-Bottom Up		\$83
Cordless Ultra	Bottom Up		\$83
	Top Down-Bottom Up		\$166
Cord Loop	Bottom Up		\$83
	Top Down-Bottom Up		\$166
DESIGNER UPGRADE OPTIONS (Add to any Lift System Upgrade Above)			ADD
Metallic Hardware or Fabric Wrapped Hardware			\$22
Scotchgard Stain Protection			\$35
MOTORIZATION*			MORE INFO
PowerTouch Rechargeable			Pg 69 \$110
Simplicity - Motor and Battery Wand			Pg 61 \$334
Simplicity Rechargeable Motorization - Motor with Integrated Battery			Pg 63 \$334
Plug-In Charger for Li-Ion Battery Pack (used for PowerTouch and Simplicity Rechargeable and is required)			Pg 65 \$27
Simplicity 5 Channel Remote			Pg 65 \$40
Simplicity 6 Channel Remote with Timer			Pg 65 \$65
Simplicity Smart Controller (NEO)			Pg 68 \$330
Top Down-Bottom Up Motorization and Solar Charge Option Pricing			Pg 9
ADDITIONAL OPTIONS			
Insulating SlumberShades	\$134 See Page 73 For More Information		
Two-On-One Head Rail	\$50 Add to Cord Lock Shade and add lift system upgrade for cordloop or cordless		
Cut Outs	\$52 Per side		
Day-Night	Price each panel as separate shade and add together		
Highlights Cornice Valance	See Page 118 For More Information		
Prints & Custom Graphics	Add 20% - Includes solid colors, Homespun, Country Woven, Florance, Strata, Angel Hair, Blossom, Strie and Terrazzo.		

*Motorized Pricing Examples pages 8, 62, 64 and 67

Debut 3/4" Single Cell
Debut 1/2" Double Cell

PRICE GROUP 8
Cord Lock
Cordless Lift & Lock

Standard Rectangular

Width In Inches

	24	30	36	42	48	54	60	66	72	84	96	108	120	132	144
36	148	165	190	212	234	253	275	294	316	363	409	454	502	547	593
42	158	181	203	229	253	277	303	326	350	402	453	503	558	610	658
48	168	194	222	248	275	301	328	357	383	438	495	552	611	667	724
54	180	205	236	266	295	324	354	384	415	476	539	600	665	729	790
60	191	220	253	284	315	349	380	414	448	512	580	647	715	785	854
66	200	234	269	303	337	372	406	443	478	549	624	698	773	843	918
72	212	245	284	323	359	398	435	472	509	587	667	746	827	905	984
78	222	261	299	336	381	418	459	501	542	623	710	794	877	963	1045
84	228	270	314	357	400	438	483	526	569	656	747	834	928	1014	1105
90	239	283	328	372	420	465	508	554	604	696	789	883	977	1073	1168
96	248	294	344	389	437	484	534	581	630	728	828	927	1029	1124	1224
108	270	318	372	423	479	528	583	635	690	797	907	1014	1126	1236	1345
120	289	345	403	459	522	576	634	693	750	867	987	1106	1225	1347	1465

Widths over 108" will be built as Two-On-One Shades.

LIFT SYSTEM AND DESIGN UPGRADES		ADD	
Cord Lock	Top Down-Bottom Up	\$64	
Cordless Lift & Lock	Bottom Up	No Charge	
	Top Down-Bottom Up	\$83	
Cordless Ultra	Bottom Up	\$83	
	Top Down-Bottom Up	\$166	
Cord Loop	Bottom Up	\$83	
	Top Down-Bottom Up	\$166	
DESIGNER UPGRADE OPTIONS (Add to any Lift System Upgrade Above)		ADD	
Metallic Hardware or Fabric Wrapped Hardware		\$22	
Scotchgard Stain Protection		\$35	
MOTORIZATION*		MORE INFO	ADD
PowerTouch Rechargeable		Pg 69	\$110
Simplicity - Motor and Battery Wand		Pg 61	\$334
Simplicity Rechargeable Motorization - Motor with Integrated Battery		Pg 63	\$334
Plug-In Charger for Li-Ion Battery Pack (used for PowerTouch and Simplicity Rechargeable and is required)		Pg 65	\$27
Simplicity 5 Channel Remote		Pg 65	\$40
Simplicity 6 Channel Remote with Timer		Pg 65	\$65
Simplicity Smart Controller (NEO)		Pg 68	\$330
Top Down-Bottom Up Motorization and Solar Charge Option Pricing		Pg 9	
ADDITIONAL OPTIONS			
Insulating SlumberShades		\$134 See Page 73 For More Information	
Two-On-One Head Rail		\$50 Add to Cord Lock Shade and add lift system upgrade for cordloop or cordless	
Cut Outs		\$52 Per side	
Day-Night		Price each panel as separate shade and add together	
Highlights Cornice Valance		See Page 118 For More Information	
Prints & Custom Graphics		Add 20% - Includes solid colors, Homespun, Country Woven, Florance, Strata, Angel Hair, Blossom, Strie and Terrazzo.	

*Motorized Pricing Examples pages 8, 62, 64 and 67

Symphony 3/8" Light Filtering

PRICE GROUP 9
Cord Lock
Cordless Lift & Lock

Standard Rectangular

Length In Inches	Width In Inches														
	24	30	36	42	48	54	60	66	72	84	96	108	120	132	144
36	127	142	163	182	201	219	238	254	273	314	353	392	434	473	513
42	136	156	175	198	219	239	261	281	302	347	391	435	482	527	569
48	144	167	191	214	238	260	283	308	331	379	428	477	528	577	626
54	155	177	203	229	255	280	305	332	359	411	466	519	575	630	683
60	164	190	219	245	272	301	328	358	387	442	501	560	619	679	739
66	172	201	232	261	291	321	351	382	413	475	540	603	668	729	794
72	182	211	245	279	310	343	376	408	440	507	577	645	715	782	851
78	191	225	258	290	329	361	397	433	468	539	614	686	759	833	904
84	197	233	271	308	345	379	418	455	492	567	646	721	802	877	956
90	206	244	283	321	362	401	439	479	522	601	682	763	845	928	1010
96	214	254	297	336	378	419	461	502	544	629	716	801	890	972	1059
108	233	275	321	365	414	457	504	549	597	689	784	877	974	1069	1163
120	249	298	348	397	451	498	548	600	648	750	854	957	1060	1165	1267

 Cord Loop Hardware is recommended on sizes within the shaded area.
Motorized Lift Systems are not offered within the shaded area.

Widths over 108" will be built as Two-On-One Shades.

FABRIC SURCHARGES		ADD	
Prints and Duotones		20%	
Flame Resistant 3/8" double cell		30%	
Flame Resistant 3/4" single cell		30%	
LIFT SYSTEM AND DESIGN UPGRADES		ADD	
Cord Lock	Top Down-Bottom Up	\$64	
Cordless Lift & Lock	Bottom Up	No Charge	
	Top Down-Bottom Up	\$83	
Cordless Ultra	Bottom Up	\$83	
	Top Down-Bottom Up	\$166	
Cord Loop	Bottom Up	\$83	
	Top Down-Bottom Up	\$166	
DESIGNER UPGRADE OPTIONS (Add to any Lift System Upgrade Above)		ADD	
Metallic Hardware or Fabric Wrapped Hardware		\$22	
Scotchgard Stain Protection		\$35	
MOTORIZATION*		MORE INFO	ADD
PowerTouch Rechargeable		Pg 69	\$110
Simplicity - Motor and Battery Wand		Pg 61	\$334
Simplicity Rechargeable Motorization - Motor with Integrated Battery		Pg 63	\$334
Plug-In Charger for Li-Lon Battery Pack (used for PowerTouch and Simplicity Rechargeable and is required)		Pg 65	\$27
Simplicity 5 Channel Remote		Pg 65	\$40
Simplicity 6 Channel Remote with Timer		Pg 65	\$65
Simplicity Smart Controller (NEO)		Pg 68	\$330
Top Down-Bottom Up Motorization and Solar Charge Option Pricing		Pg 9	
ADDITIONAL OPTIONS			
Insulating SlumberShades		\$134 See Page 73 For More Information	
Two-On-One Head Rail		\$50 Add to Cord Lock Shade and add lift system upgrade for cordloop or cordless	
Cut Outs		\$52 Per side	
Day-Night		Price each panel as separate shade and add together	
Highlights Cornice Valance		See Page 118 For More Information	

*Motorized Pricing Examples pages 8, 62, 64 and 67

Symphony 3/8" Blackout

PRICE GROUP 10
Cord Lock
Cordless Lift & Lock

Standard Rectangular

		Width In Inches														
		24	30	36	42	48	54	60	66	72	84	96	108	120	132	144
Length In Inches	36	166	185	212	237	262	285	310	331	355	409	459	510	565	615	667
	42	177	203	228	258	285	311	340	366	393	452	509	566	627	686	740
	48	188	218	249	279	310	338	368	401	431	493	557	621	687	751	814
	54	202	231	264	298	332	364	397	432	467	535	606	675	748	819	888
	60	214	247	285	319	354	392	427	466	504	575	652	728	805	883	961
	66	224	262	302	340	379	418	457	497	537	618	702	784	869	948	1033
	72	237	275	319	363	403	446	489	531	572	660	751	839	930	1017	1107
	78	249	293	336	377	428	470	517	563	609	701	799	892	987	1083	1176
	84	257	303	353	401	449	493	544	592	640	738	840	938	1043	1141	1243
	90	268	318	368	418	471	522	571	623	679	782	887	992	1099	1207	1313
	96	279	331	387	437	492	545	600	653	708	818	931	1042	1157	1264	1377
	108	303	358	418	475	539	595	656	714	777	896	1020	1141	1267	1390	1512
120	324	388	453	517	587	648	713	780	843	975	1111	1245	1378	1515	1648	

 Cord Loop Hardware is recommended on sizes within the shaded area. Motorized Lift Systems are not offered within the shaded area.

Widths over 120" will be built as Two-On-One Shades.

LIFT SYSTEM AND DESIGN UPGRADES		ADD	
Cord Lock	Top Down-Bottom Up	\$64	
Cordless Lift & Lock	Bottom Up	No Charge	
	Top Down-Bottom Up	\$83	
Cord Loop	Bottom Up	\$83	
	Top Down-Bottom Up	\$166	
DESIGNER UPGRADE OPTIONS (Add to any Lift System Upgrade Above)		ADD	
Metallic Hardware or Fabric Wrapped Hardware		\$22	
Scotchgard Stain Protection		\$35	
MOTORIZATION*		MORE INFO	ADD
PowerTouch Rechargeable		Pg 67	\$110
Simplicity - Motor and Battery Wand		Pg 61	\$334
Simplicity Rechargeable Motorization - Motor with Integrated Battery		Pg 63	\$334
Plug-In Charger for Li-Ion Battery Pack (used for PowerTouch and Simplicity Rechargeable and is required)		Pg 65	\$27
Simplicity 5 Channel Remote		Pg 65	\$40
Simplicity 6 Channel Remote with Timer		Pg 65	\$65
Simplicity Smart Controller (NEO)		Pg 68	\$330
Top Down-Bottom Up Motorization and Solar Charge Option Pricing		Pg 9	
ADDITIONAL OPTIONS			
Insulating SlumberShades		\$134 See Page 73 For More Information	
Two-On-One Head Rail		\$50 Add to Cord Lock Shade and add lift system upgrade for cordloop or cordless	
Cut Outs		\$52 Per side	
Day-Night		Price each panel as separate shade and add together	
Highlights Cornice Valance		See Page 118 For More Information	

*Motorized Pricing Examples pages 8, 62, 64 and 67

Prelude 3/4" Light Filtering

PRICE GROUP 11
Cord Lock
Cordless Lift & Lock

		Width In Inches												
		24	30	36	42	48	54	60	66	72	84	96	108	120
Length In Inches	36	115	128	147	164	181	198	215	229	246	283	318	353	391
	42	123	141	158	179	198	216	235	253	272	313	352	392	434
	48	130	151	172	193	215	234	255	278	298	342	386	430	476
	54	140	160	183	207	230	252	275	299	324	370	420	468	518
	60	148	171	198	221	245	271	296	323	349	398	451	504	558
	66	155	181	209	235	262	289	316	344	372	428	486	543	602
	72	164	190	221	252	279	309	339	368	396	457	520	581	644
	78	172	203	233	261	297	325	358	390	422	486	553	618	684
	84	178	210	244	278	311	342	377	410	443	511	582	649	722
	90	186	220	255	289	326	361	396	432	470	541	614	687	761
	96	193	229	268	303	341	378	415	452	490	567	645	721	801
	108	210	248	289	329	373	412	454	495	538	621	706	790	877
120	225	269	314	358	406	449	494	540	584	675	769	862	954	

■ Cord Loop Hardware is recommended on sizes within the shaded area.
Motorized lift systems are not offered within the shaded area.

Prelude Cellular Shades

LIFT SYSTEM AND DESIGN UPGRADES		ADD	
Cord Lock	Top Down-Bottom Up	\$64	
Cordless Lift & Lock	Bottom Up	No Charge	
	Top Down-Bottom Up	\$83	
Cordless Ultra	Bottom Up	\$83	
	Top Down-Bottom Up	\$166	
Cord Loop	Bottom Up	\$83	
	Top Down-Bottom Up	\$166	
DESIGNER UPGRADE OPTIONS (Add to any Lift System Upgrade Above - Not available on Cord Lock)		ADD	
Metallic Hardware (Not available on Lift & Lock or Cord Lock) or Fabric Wrapped Hardware (Not available on Cord Lock)		\$22	
MOTORIZATION*		MORE INFO	ADD
PowerTouch Rechargeable		Pg 67	\$110
Simplicity - Motor and Battery Wand		Pg 61	\$334
Simplicity Rechargeable Motorization - Motor with Integrated Battery		Pg 63	\$334
Plug-In Charger for Li-Ion Battery Pack (used for PowerTouch and Simplicity Rechargeable and is required)		Pg 65	\$27
Simplicity 5 Channel Remote		Pg 65	\$40
Simplicity 6 Channel Remote with Timer		Pg 65	\$65
Simplicity Smart Controller (NEO)		Pg 68	\$330
Top Down-Bottom Up Motorization not available on Prelude		Pg 9	
ADDITIONAL OPTIONS AND ACCESSORIES			
Insulating SlumberShades		Not Available	
Two-On-One/Three-On-One Head Rail		\$50 Add to Cord Lock Shade and add lift system upgrade for cordloop or cordless	
Highlights Cornice Valance		See Page 118 For More Information	
5 foot expandable pole		\$37	

*Motorized Pricing Examples pages 8, 62, 64 and 67

Prelude 3/4" Blackout

PRICE GROUP 12
Cord Lock
Cordless Lift & Lock

Prelude Cellular Shades

		Width In Inches												
		24	30	36	42	48	54	60	66	72	84	96	108	120
Length In Inches	36	156	173	199	222	245	268	291	310	333	383	430	477	528
	42	167	191	214	242	268	292	318	342	368	423	476	530	586
	48	176	204	233	261	291	316	345	376	403	462	522	581	643
	54	189	216	248	280	311	341	372	404	438	500	567	632	700
	60	200	231	268	299	331	366	400	437	472	538	609	681	754
	66	210	245	283	318	354	391	427	465	503	578	657	734	813
	72	222	257	299	341	377	418	458	497	535	617	702	785	870
	78	233	275	315	353	401	439	484	527	570	657	747	835	924
	84	241	284	330	376	420	462	509	554	599	690	786	877	975
	90	252	297	345	391	441	488	535	584	635	731	829	928	1028
	96	261	310	362	410	461	511	561	611	662	766	871	974	1082
	108	284	335	391	445	504	557	613	669	727	839	954	1067	1184
120	304	364	424	484	549	607	667	729	789	912	1039	1164	1288	

■ Cord Loop Hardware is recommended on sizes within the shaded area.

Motorized lift systems are not offered within the shaded area.

LIFT SYSTEM AND DESIGN UPGRADES		ADD	
Cord Lock	Top Down-Bottom Up	\$64	
Cordless Lift & Lock	Bottom Up	No Charge	
	Top Down-Bottom Up	\$83	
Cordless Ultra	Bottom Up	\$83	
	Top Down-Bottom Up	\$166	
Cord Loop	Bottom Up	\$83	
	Top Down-Bottom Up	\$166	
DESIGNER UPGRADE OPTIONS (Add to any Lift System Upgrade Above - Not available on Cord Lock)		ADD	
Metallic Hardware (Not available on Lift & Lock or Cord Lock) or Fabric Wrapped Hardware (Not available on Cord Lock)		\$22	
MOTORIZATION*		MORE INFO	ADD
PowerTouch Rechargeable		Pg 67	\$110
Simplicity - Motor and Battery Wand		Pg 61	\$334
Simplicity Rechargeable Motorization - Motor with Integrated Battery		Pg 63	\$334
Plug-In Charger for Li-Ion Battery Pack (used for PowerTouch and Simplicity Rechargeable and is required)		Pg 65	\$27
Simplicity 5 Channel Remote		Pg 65	\$40
Simplicity 6 Channel Remote with Timer		Pg 65	\$65
Simplicity Smart Controller (NEO)		Pg 68	\$330
Top Down-Bottom Up Motorization not available on Prelude		Pg 9	
ADDITIONAL OPTIONS AND ACCESSORIES			
Insulating SlumberShades		Not Available	
Two-On-One/Three-On-One Head Rail		\$50 Add to Cord Lock Shade and add lift system upgrade for cordloop or cordless	
Highlights Cornice Valance		See Page 118 For More Information	
5 foot expandable pole		\$37	

*Motorized Pricing Examples pages 8, 62, 64 and 67

Ovation Cellular Slider Shade Size Standards



Ovation Cellular Slider Standard

ALL FABRICS	Minimum Width	12"
	Minimum Length	24"

Light Filtering	Price Group	Page		Ovation Cellular Slider
Debut 1/2" Single Debut 1/2" Double Premiere 1/2" Symphony 3/8"	13	30	Maximum Width & Length	120"* x 108"
Verona 3/4" Boutique 3/4" Debut 3/4" Linen Weave 3/4" Premiere 3/4"	13	30	Maximum Width & Length	168"* x 120"
Prelude 3/4"	14	30	Maximum Width & Length	168"* x 120"

Room Darkening & Blackout	Price Group	Page		Ovation Cellular Slider
Verona 3/4" Boutique 3/4" Linen Weave 3/4" Premiere 3/4"	15	31	Maximum Width & Length	168"* x 120"
Prelude 3/4"	16	31	Maximum Width & Length	168"* x 120"

Maximum Square Footage Side=100"
Split=140"

	Ovation Cellular Slider
More Information On Page	Page 71



- * Split stack sliders are available in widths up to 240"; however, if the width exceeds 120", it will be fabricated as two separate sliders. The supplied valance will create the appearance of a single slider.
- ** Split stack sliders are available to 336", however if the width exceeds 168", the shade will be fabricated as two separate sliders. Supplied valance will create the appearance of a single slider. Please call customer service for assistance.
- *** Prelude split stack can go up to 190" wide on one head rail.

LIGHT FILTERING FABRICS

Boutique 3/4"
 Debut 1/2" Single Cell
 Debut 1/2" Double Cell
 Debut 3/4" Single Cell
 Linen Weave 3/4"

Premiere 1/2"
 Premiere 3/4"
 Symphony 3/8"
 Verona 3/4"
 Virtuoso 1/2"

**PRICE GROUP 13
 Ovation Cellular Slider**

Width In Inches

	24	30	36	42	48	54	60	66	72	78	84	96	108	120	132	144	156	168
36	464	502	547	588	623	664	707	744	785	829	865	937	1008	1084	1158	1234	1311	1385
42	493	541	589	636	676	722	770	813	862	906	946	1029	1108	1198	1286	1375	1462	1551
48	526	574	633	682	729	778	831	884	935	979	1031	1128	1214	1312	1408	1506	1602	1700
54	555	613	673	730	779	834	889	951	1008	1060	1116	1219	1317	1425	1533	1639	1748	1855
60	587	648	712	775	831	891	954	1019	1080	1138	1196	1313	1422	1537	1657	1774	1892	2012
66	620	687	756	823	884	950	1014	1089	1152	1219	1275	1408	1525	1652	1775	1902	2027	2152
72	654	724	797	872	942	1009	1077	1157	1226	1298	1360	1507	1627	1769	1910	2052	2194	2332
78	687	763	842	922	995	1069	1141	1228	1301	1377	1444	1597	1730	1880	2029	2177	2329	2478
84	722	801	883	973	1051	1128	1206	1295	1377	1456	1527	1692	1835	1991	2152	2309	2468	2625
90	753	839	930	1022	1102	1186	1273	1368	1451	1535	1615	1788	1936	2110	2285	2461	2636	2811
96	784	876	974	1070	1155	1242	1340	1437	1527	1617	1699	1884	2042	2222	2402	2582	2764	2943
108	814	911	1016	1120	1207	1301	1404	1504	1601	1699	1782	1982	2148	2334	2517	2703	2887	3072
114	856	955	1069	1176	1269	1366	1482	1583	1687	1791	1879	2088	2266	2456	2637	2822	3005	3189
120	899	1003	1124	1234	1330	1432	1557	1663	1771	1883	1975	2196	2382	2577	2768	2958	3149	3340

Prelude 3/4" Light Filtering

**PRICE GROUP 14
 Ovation Cellular Slider**

Width In Inches

	24	30	36	42	48	54	60	66	72	78	84	96	108	120	132	144	156	168
36	344	373	406	437	463	494	525	553	584	616	643	696	749	806	861	918	974	1030
42	367	402	438	473	503	537	573	604	640	674	703	765	824	891	956	1023	1088	1153
48	391	426	470	507	541	578	618	657	695	729	766	838	902	975	1047	1120	1191	1264
54	413	456	500	542	579	621	661	707	749	788	829	907	980	1060	1140	1219	1300	1379
60	436	482	530	576	618	663	710	757	802	846	890	976	1057	1143	1233	1319	1407	1496
66	460	511	562	612	657	706	754	810	856	907	948	1047	1134	1228	1320	1414	1507	1601
72	486	539	593	648	701	750	801	860	911	965	1011	1121	1210	1315	1421	1526	1631	1735
78	511	567	626	685	739	794	848	913	967	1024	1073	1188	1287	1398	1509	1620	1732	1843
84	537	595	657	723	782	838	897	963	1024	1082	1135	1259	1365	1481	1601	1718	1836	1953
90	559	623	692	760	819	882	946	1017	1080	1142	1201	1330	1440	1569	1700	1830	1961	2090
96	583	651	724	795	859	924	997	1069	1135	1203	1263	1401	1519	1653	1786	1920	2055	2188
102	605	677	756	833	898	967	1044	1118	1190	1263	1325	1474	1597	1736	1872	2010	2147	2285
108	637	711	794	874	944	1016	1102	1178	1254	1332	1397	1553	1685	1827	1962	2098	2234	2372
114	668	746	836	918	990	1064	1158	1236	1317	1400	1468	1633	1772	1917	2059	2200	2341	2484
120	700	781	874	961	1036	1114	1216	1295	1381	1469	1538	1712	1859	2007	2155	2303	2448	2598

PRODUCT INFORMATION	
See Page 69 for detailed information.	
DESIGN UPGRADES	
Left or Right Stack	Included, specify when ordering
Center Stack	Add \$84
Split Stack*	Price by dividing the full width measurement in half. Price as two separate units and add together.
Dual Panel**	Price as two separate units and add together.
FABRIC SURCHARGES	
Prints and Duotones	Add 20%
Flame Resistant 3/8" Double Cell	Add 30%
Flame Resistant 3/4" Single Cell	Add 30%

* Split stack sliders are available in widths up to 240". If the width exceeds 120", it will be fabricated as two separate sliders. The supplied valance will create the appearance of a single slider.

** A Dual Panel Stack Slider has a center opening design with a different fabric on each side, each of which can span the full width of the window. Both panels will be of equal width unless otherwise specified.

ROOM DARKENING & BLACKOUT FABRICS

Boutique 3/4"
Linen Weave 3/4"

Premiere 3/4"
Verona 3/4"

PRICE GROUP 15
Ovation Cellular Slider

Ovation Cellular Sliders

		Width In Inches																	
		24	30	36	42	48	54	60	66	72	78	84	96	108	120	132	144	156	168
Length In Inches	36	604	653	712	765	810	864	920	968	1021	1078	1125	1219	1311	1410	1506	1605	1705	1801
	42	641	704	766	827	879	939	1001	1057	1121	1178	1230	1338	1441	1558	1672	1788	1901	2017
	48	684	747	823	887	948	1012	1081	1150	1216	1273	1341	1467	1579	1706	1831	1958	2083	2210
	54	722	797	875	949	1013	1085	1156	1237	1311	1378	1451	1585	1713	1853	1993	2131	2273	2412
	60	764	843	926	1008	1081	1159	1241	1325	1404	1480	1555	1707	1849	1999	2155	2307	2460	2616
	66	806	894	983	1070	1150	1235	1319	1416	1498	1585	1658	1831	1983	2148	2308	2473	2636	2798
	72	851	942	1037	1134	1225	1312	1401	1505	1594	1688	1768	1960	2116	2300	2483	2668	2853	3032
	78	894	992	1095	1199	1294	1390	1484	1597	1692	1791	1878	2077	2249	2444	2638	2831	3028	3222
	84	939	1042	1148	1265	1367	1467	1568	1684	1791	1893	1986	2200	2386	2589	2798	3002	3209	3413
	90	979	1091	1209	1329	1433	1542	1655	1779	1887	1996	2100	2325	2517	2743	2971	3200	3427	3655
	96	1020	1139	1267	1391	1502	1615	1742	1869	1986	2103	2209	2450	2655	2889	3123	3357	3594	3826
108	1059	1185	1321	1456	1570	1692	1826	1956	2082	2209	2317	2577	2793	3035	3273	3514	3754	3994	
114	1113	1242	1390	1529	1650	1776	1927	2058	2194	2329	2443	2715	2946	3193	3429	3669	3907	4146	
120	1169	1304	1462	1605	1729	1862	2025	2162	2303	2448	2568	2855	3097	3351	3599	3846	4094	4342	

Prelude 3/4" Blackout

PRICE GROUP 16
Ovation Cellular Slider

		Width In Inches																	
		24	30	36	42	48	54	60	66	72	78	84	96	108	120	132	144	156	168
Length In Inches	36	465	504	549	590	626	667	709	747	789	832	869	940	1012	1089	1163	1240	1315	1391
	42	496	543	592	639	680	725	774	816	864	910	950	1033	1113	1203	1291	1382	1469	1557
	48	528	576	635	685	731	781	835	887	939	985	1035	1132	1218	1317	1414	1512	1608	1707
	54	558	616	675	732	782	839	893	955	1012	1064	1120	1225	1323	1431	1539	1646	1755	1862
	60	589	651	716	778	835	896	959	1022	1083	1143	1202	1318	1427	1544	1665	1781	1900	2020
	66	621	690	759	827	887	954	1018	1094	1156	1225	1280	1414	1531	1658	1782	1909	2035	2162
	72	657	728	801	875	947	1013	1082	1161	1230	1303	1365	1514	1634	1776	1919	2061	2202	2343
	78	690	766	846	925	998	1072	1145	1233	1306	1383	1449	1604	1738	1888	2038	2187	2339	2489
	84	725	804	887	977	1056	1132	1211	1301	1383	1461	1533	1700	1843	2000	2162	2320	2479	2637
	90	755	842	935	1026	1106	1191	1278	1373	1458	1542	1622	1796	1944	2119	2295	2471	2648	2822
	96	788	879	978	1074	1160	1248	1346	1444	1533	1625	1706	1892	2051	2232	2412	2592	2775	2954
102	817	914	1021	1125	1213	1306	1410	1510	1607	1706	1789	1990	2156	2344	2528	2714	2899	3085	
108	860	960	1072	1180	1275	1372	1488	1591	1693	1799	1886	2097	2275	2467	2649	2833	3016	3203	
114	902	1008	1129	1240	1337	1437	1564	1669	1778	1890	1982	2205	2393	2588	2780	2970	3161	3354	
120	945	1055	1180	1298	1399	1504	1642	1749	1865	1984	2077	2312	2510	2710	2910	3110	3305	3508	

PRODUCT INFORMATION	
See Page 69 for detailed information.	
DESIGN UPGRADES	
Left or Right Stack	Included, specify when ordering
Center Stack	Add \$84
Split Stack*	Price by dividing the full width measurement in half. Price as two separate units and add together.
Dual Panel**	Price as two separate units and add together.
FABRIC SURCHARGES	
Prints and Duotones	Add 20%
Flame Resistant 3/8" Double Cell	Add 30%
Flame Resistant 3/4" Single Cell	Add 30%

* Split stack sliders are available in widths up to 240". If the width exceeds 120", it will be fabricated as two separate sliders. The supplied valance will create the appearance of a single slider.

** A Dual Panel Stack Slider has a center opening design with a different fabric on each side, each of which can span the full width of the window. Both panels will be of equal width unless otherwise specified.

Specialty Shaped Shades



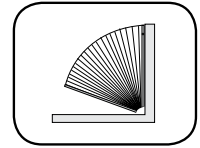
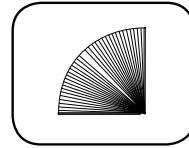
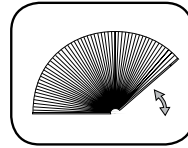
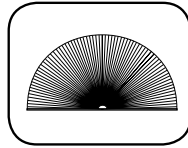

		Starburst Non-Movable Arch	Starburst Movable Arch	Quarter Round Non-Movable	Quarter Round Movable
ALL FABRICS (except 3/4" Prelude)	Minimum Width	18"	18"	9"	9"
	Minimum Length	9"	9"	9"	9"
Prelude 3/4"	Minimum Width	12"	12"	12"	12"
	Minimum Length	12"	12"	12"	12"

Light Filtering	Price Group	Page		Starburst Non-Movable Arch	Starburst Movable Arch	Quarter Round Non-Movable	Quarter Round Movable
Verona 3/4"	17	35	Maximum Width & Length	72" x 36"	72" x 36"	48" x 48"	48" x 48"
Boutique 3/4"				72" x 36"	72" x 36"	48" x 48"	48" x 46"
Debut 1/2" Double				60" x 48"	72" x 36"	48" x 48"	48" x 48"
Debut 1/2" Single				60" x 48"	72" x 36"	52" x 52"	48" x 48"
Debut 3/4"				60" x 48"	72" x 36"	48" x 48"	48" x 48"
Linen Weave 3/4"				72" x 36"	72" x 36"	48" x 48"	48" x 48"
Premiere 1/2"				60" x 48"	72" x 36"	48" x 48"	48" x 48"
Premiere 3/4"				72" x 36"	72" x 36"	48" x 48"	48" x 48"
Symphony 3/8"				96" x 48"	72" x 36"	52" x 52"	48" x 48"
Prelude 3/4"	18	35	Max Width & Length	84" x 42"	84" x 42"	42" x 42"	42" x 42"

Room Darkening & Blackout	Price Group	Page #		Starburst Non-Movable Arch	Starburst Movable Arch	Quarter Round Non-Movable	Quarter Round Movable
Verona 3/4"	19	36	Maximum Width & Length	72" x 36"	72" x 36"	48" x 48"	48" x 48"
Boutique 3/4"				72" x 36"	72" x 36"	48" x 48"	48" x 48"
Linen Weave 3/4"				72" x 36"	72" x 36"	48" x 48"	48" x 48"
Premiere 1/2"				60" x 48"	72" x 36"	48" x 48"	48" x 48"
Premiere 3/4"				72" x 36"	72" x 36"	48" x 48"	48" x 48"
Symphony 3/8"				96" x 48"	72" x 36"	52" x 52"	48" x 48"
Prelude 3/4"	20	36	Max Width & Length	84" x 42"	84" x 42"	42" x 42"	42" x 42"

	Starburst Non-Movable Arch	Starburst Movable Arch	Quarter Round Non-Movable	Quarter Round Movable
More Information On Page	Page 75	Page 75	Page 78	Page 78

* Starburst Movable Arches are available as inside mount only.
 ** Through our maximum width is 84" and our maximum is 72" on Sunset Arches, there are limitations on some larger sizes due to excessive weight. If the Sunset width exceeds 66", the maximum length is 60". If the Sunset width exceeds 72", the maximum length is 48".

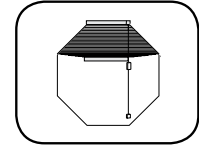
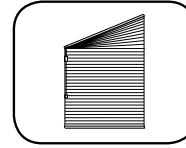
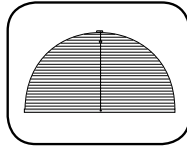

		Sunset Arch	Trapezoid	Octagon
ALL FABRICS (except 3/4" Prelude)	Minimum Width	18"	12"	12"
	Minimum Length	6"	12"	12"
Prelude 3/4"	Minimum Width	18"	12"	8"
	Minimum Length	6"	12"	8"

Light Filtering	Price Group	Page		Sunset Arch	Price Group	Page	Trapezoid	Octagon
Verona 3/4"	21	37	Maximum Width & Length	72" x 60"	25	39	48" x 72"	48" x 48"
Boutique 3/4"				72" x 60"			48" x 72"	48" x 48"
Debut 1/2" Double				84" x 72" **			60" x 72"	48" x 48"
Debut 1/2" Single				84" x 72" **			60" x 72"	48" x 48"
Debut 3/4"				84" x 72" **			60" x 72"	48" x 48"
Linen Weave 3/4"				72" x 60"			48" x 72"	48" x 48"
Premiere 1/2"				84" x 72" **			60" x 72"	48" x 48"
Premiere 3/4"				84" x 72" **			48" x 72"	48" x 48"
Symphony 3/8"				84" x 72" **			60" x 72"	48" x 48"
Prelude 3/4"	29	37	Max Width & Length	84" x 48"	26	39	48" x 84"	30" x 30"

Room Darkening & Blackout	Price Group	Page		Sunset Arch	Price Group	Page	Trapezoid	Octagon
Verona 3/4"	23	38	Maximum Width & Length	60" x 60"	27	40	48" x 72"	48" x 48"
Boutique 3/4"				60" x 60"			48" x 72"	48" x 48"
Linen Weave 3/4"				60" x 60"			48" x 72"	48" x 48"
Premiere 1/2"				60" x 60"			48" x 72"	48" x 48"
Premiere 3/4"				60" x 60"			48" x 72"	48" x 48"
Symphony 3/8"				NA			60" x 72"	48" x 48"
Prelude 3/4"	24	38	Max Width & Length	84" x 48"	28	40	48" x 84"	30" x 30"

	Sunset Arch	Trapezoid	Octagon
More Information On Page	Page 76	Page 80	Page 80

*Starburst Movable Arches are available as inside mount only.

**Through our maximum width is 84" and our maximum is 72" on Sunset Arches, there are limitations on some larger sizes due to excessive weight. If the Sunset width exceeds 66", the maximum length is 60". If the Sunset width exceeds 72", the maximum length is 48".

LIGHT FILTERING FABRICS

Boutique 3/4"
 Debut 1/2" Single Cell
 Debut 1/2" Double Cell
 Debut 3/4" Single Cell
 Linen Weave 3/4"

Premiere 1/2"
 Premiere 3/4"
 Symphony 3/8"
 Verona 3/4"

PRICE GROUP 17
 Starburst Arches
 Quarter Rounds

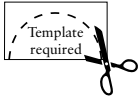

For widths wider than 58"

	Width In Inches												
	24	30	36	42	48	54	60	66	72	78	84	90	96
Non-Movable Starburst	249	283	322	367	440	504	569	642	723	809	899	997	1108
Movable Starburst	353	400	456	515	616	690	777	869	970				
Non-Movable Quarter Rounds	322	367	419	478	543	618							
Movable Quarter Rounds	440	499	567	640	723								

Product Information: All fabrics are not available in all widths, lengths and hardware options. Refer to Size Specifications on page 33 and 34 for availability. See pages 75 and 78-79 for detailed information. Templates required on non-perfect non-movable Starburst Arches and Quarter Rounds. Movable Starburst Arch shades are for inside and shallow mount applications only.

Prelude 3/4" Light Filtering

PRICE GROUP 18
 Starburst Arches
 Quarter Rounds

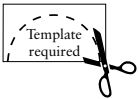

For widths wider than 58"

	Width In Inches												
	24	30	36	42	48	54	60	66	72	78	84		
Stationary Starburst	225	255	290	331	396	454	513	578	651	729	810		
Movable Starburst	318	360	411	464	555	621	700	783	873	961	1058		
Stationary Quarter Round	293	332	377	431									
Movable Quarter Round	NOT AVAILABLE												

FABRIC SURCHARGES		ADD
Scotchgard Stain Protector		\$35
Debut 1/2" Single Cell Print Fabric	Includes: Homespun, Country Woven, Florance, Strata, Angel Hair, Blossom, Terrazzo and Strie	20%
Debut 1/2" Double Cell Print Fabric Debut 3/4" Single Cell Print Fabric	Includes: Homespun, Country Woven, Florance, Strata and Angel Hair	20%
Premiere Fabric	Includes: Homespun, Country Woven, Florance, Spheres, Strata, Tuscan Scroll, Angel Hair, Blossom, and Gradients	20%
Symphony Fabric	Symphony Prints and Duotones	20%
	Symphony Double Cell Flame Resistant	30%
PRICING INFORMATION		
Starburst Arches	Price according to the largest radius measurement. If the height is greater than the width, take height X 2 and use that number to determine pricing. Metallic rails available.	
Quarter Rounds	Price according to the largest radius measurement.	
HARDWARE UPGRADE SURCHARGES* AND ACCESSORIES		ADD
6 Foot Expandable Pole		\$37
12 Foot Expandable Pole		\$46

ROOM DARKENING & BLACKOUT FABRICS

Boutique 3/4" Premiere 3/4"
 Linen Weave 3/4" Symphony 3/8"
 Premiere 1/2" Verona 3/4"

PRICE GROUP 19
Starburst Arches
Quarter Round

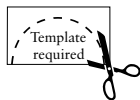

For widths wider than 58"

	Width In Inches												
	24	30	36	42	48	54	60	66	72	78	84	90	96
Non-Movable Starburst	324	368	419	477	572	655	740	835	940	1052	1169	1296	1440
Movable Starburst	459	520	593	670	801	897	1010	1130	1261				
Non-Movable Quarter Rounds	419	477	545	621	706	803							
Movable Quarter Rounds	572	649	737	832	940								

Product Information: All fabrics are not available in all widths, lengths and hardware options. Refer to Size Specifications on page 33 and 34 for availability. See pages 753 and 78-79 for detailed information. Templates required on non-perfect non-movable Starburst Arches and Quarter Rounds. Movable Starburst Arch shades are for inside and shallow mount applications only.

Prelude 3/4" Blackout

PRICE GROUP 20
Starburst Arches
Quarter Rounds

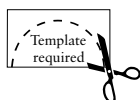

For widths wider than 58"

	Width In Inches										
	24	30	36	42	48	54	60	66	72	78	84
Stationary Starburst	304	345	392	447	535	613	693	781	879	985	1094
Movable Starburst	430	486	555	627	750	839	945	1058	1179	1298	1429
Stationary Quarter Round	396	449	509	582							
Movable Quarter Round	Not Available										

Product Information: See pages 111 and 114 for detailed information. Templates required on non-perfect non-movable Starburst Arches and Quarter Rounds. Movable Starburst Arch shades are for inside and shallow mount applications only.

FABRIC SURCHARGES		ADD
Scotchgard Stain Protector		\$35
Premiere Fabric	Includes: Homespun, Country Woven, Florance, Spheres, Strata, Tuscan Scroll, Angel Hair, Blossom, and Gradients	20%
PRICING INFORMATION		
Starburst Arches	Price according to the largest radius measurement. If the height is greater than the width, take height X 2 and use that number to determine pricing. Metallic rails available.	
Quarter Rounds	Price according to the largest radius measurement.	
HARDWARE UPGRADE SURCHARGES* AND ACCESSORIES		ADD
6 Foot Expandable Pole		\$37
12 Foot Expandable Pole		\$46

Please note: On the Stationary Starburst Arches when the fabric wrapped hardware is selected, the fabric wrap will be spliced in the center of the base rail.

LIGHT FILTERING

Boutique 3/4"
 Debut 1/2" Single Cell
 Debut 1/2" Double Cell
 Debut 3/4" Single Cell
 Linen Weave 3/4"

Premiere 1/2"
 Premiere 3/4"
 Symphony 3/8"
 Verona 3/4"

PRICE GROUP 21
Sunset Movable Arches

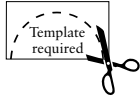

For widths wider than 58"

		Width In Inches										
		24	30	36	42	48	54	60	66	72	78	84
Length In Inches	Half Round	323	360	381	429	458	514	545	600	656	708	781
	36	419	459	481	515	538	577	595	626	656	685	711
	42	441	488	508	559	578	623	643	680	711	748	781
	48	468	515	543	593	615	652	692	729	768	807	850
	60	513	577	605	669	699	759	790	837	882	932	978
	72	563	633	671	744	781	852	894	944	1003	1052	1109

Product Information: All fabrics are not available in all widths, lengths and hardware options. Refer to Size Specifications on page 34 for availability. See pages 76-77 for detailed information. Templates required on non-perfect Sunset Arches.

Prelude 3/4" Light Filtering

PRICE GROUP 22
Sunset Movable Arches

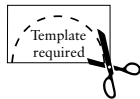

For widths wider than 58"

		Width In Inches										
		24	30	36	42	48	54	60	66	72	78	84
Length In Inches	Half Round	291	324	343	387	413	463	491	540	591	638	703
	36	378	414	433	464	485	520	536	564	591	617	640
	42	397	440	458	504	521	561	579	612	640	674	703
	48	422	464	489	534	554	587	623	657	692	727	765

FABRIC SURCHARGES		ADD
Scotchgard Stain Protector		\$35
Debut 1/2" Single Cell Print Fabric	Includes: Homespun, Country Woven, Florance, Strata, Angel Hair, Blossom, Terrazzo and Strie	20%
Debut 1/2" Double Cell Print Fabric Debut 3/4" Single Cell Print Fabric	Includes: Homespun, Country Woven, Florance, Strata and Angel Hair	20%
Premiere Fabric	Includes: Homespun, Country Woven, Florance, Spheres, Strata, Tuscan Scroll, Angel Hair, Blossom, and Gradients	20%
Symphony Fabric	Symphony Prints and Duotones	20%
	Symphony Double Cell Flame Resistant	30%
HARDWARE UPGRADE SURCHARGES AND ACCESSORIES		ADD
6 Foot Expandable Pole		\$37
12 Foot Expandable Pole		\$46

ROOM DARKENING & BLACKOUT FABRICS

Boutique 3/4"
 Linen Weave 3/4"
 Premiere 1/2"

Premiere 3/4"
 Verona 3/4"

PRICE GROUP 23
Sunset Movable Arches

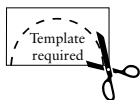

For widths wider than 58"

		Width In Inches						
		24	30	36	42	48	54	60
Length In Inches	Half Round	420	468	495	558	595	668	709
	36	545	597	625	670	699	750	774
	42	573	634	660	727	751	810	836
	48	608	670	706	771	800	848	900
	60	667	750	787	870	909	987	1027

Product Information: All fabrics are not available in all widths, lengths and hardware options. Refer to Size Specifications on page 34 for availability. See pages 76-77 for detailed information. Templates required on non-perfect Sunset Arches.

Prelude 3/4" Blackout

PRICE GROUP 24
Sunset Movable Arches

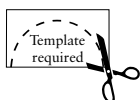

For widths wider than 58"

		Width In Inches										
		24	30	36	42	48	54	60	66	72	78	84
Length In Inches	Half Round	393	438	464	523	558	626	663	729	798	862	950
	36	511	559	585	627	655	702	724	762	798	833	864
	42	536	594	619	681	704	758	782	827	864	910	950
	48	570	627	661	721	748	793	842	887	935	982	1033

Product Information: See pages 112-113 for detailed information. Templates required on non-perfect Sunset Arches.

FABRIC SURCHARGES		ADD
Scotchgard Stain Protector		\$35
Premiere Fabric	Includes: Homespun, Country Woven, Florance, Spheres, Strata, Tuscan Scroll, Angel Hair, Blossom, and Gradients	20%
HARDWARE UPGRADE SURCHARGES AND ACCESSORIES		ADD
6 Foot Expandable Pole		\$37
12 Foot Expandable Pole		\$46

LIGHT FILTERING

Boutique 3/4"
 Debut 1/2" Single Cell
 Debut 1/2" Double Cell
 Debut 3/4" Single Cell
 Linen Weave 3/4"

Premiere 1/2"
 Premiere 3/4"
 Symphony 3/8"
 Verona 3/4"

PRICE GROUP 25
 Trapezoids and Octagons

		Width In Inches						
		24	30	36	42	48	54	60
Length In Inches	36	446	473	506	542	573	603	633
	42	462	494	530	569	603	638	675
	48	477	514	556	597	633	672	713
	54	493	532	578	621	663	707	749
	60	510	553	602	648	693	745	790
	66	526	573	626	676	727	779	825
	72	542	591	648	704	759	813	869

All fabrics are not available in all widths, lengths and applications. Refer to Size Specifications on page 34 for availability.
Product Information: See pages 80-81 for detailed information. Width, length and one side are required measurements for Octagon Shades. Trapezoid orders must be emailed in with a diagram that includes the measurements for 4 sides. No templates are required for Trapezoid Shades. * Virtuoso fabrics are available as Octagons only.

Prelude 3/4" Light Filtering

PRICE GROUP 26
 Trapezoids and Octagons

		Width In Inches						
		24	30	36	42	48	54	60
Length In Inches	36	402	426	456	488	516	543	570
	42	416	445	477	513	543	575	608
	48	430	463	501	538	570	605	642
	54	444	479	521	559	597	637	675
	60	459	498	542	584	624	671	711
	66	474	516	564	609	655	702	743
	72	488	532	584	634	684	732	783

Product Information: See page 115-116 for detailed information. Templates required on all Octagon orders.

FABRIC SURCHARGES		ADD
Scotchgard Stain Protector		\$35
Debut 1/2" Single Cell Print Fabric	Includes: Homespun, Country Woven, Florance, Strata, Angel Hair, Blossom, Terrazzo and Strie	20%
Debut 1/2" Double Cell Print Fabric Debut 3/4" Single Cell Print Fabric	Includes: Homespun, Country Woven, Florance, Strata and Angel Hair	20%
Premiere Fabric	Includes: Homespun, Country Woven, Florance, Spheres, Strata, Tuscan Scroll, Angel Hair, Blossom, and Gradients	20%
Symphony Fabric	Symphony Prints and Duotones	20%
	Symphony Double Cell Flame Resistant	30%
HARDWARE UPGRADE SURCHARGES AND ACCESSORIES		ADD
6 Foot Expandable Pole		\$37
12 Foot Expandable Pole		\$46

ROOM DARKENING & BLACKOUT FABRICS

Boutique 3/4"
 Linen Weave 3/4"
 Premiere 1/2"

Premiere 3/4"
 Symphony 3/8"
 Verona 3/4"

PRICE GROUP 27
Trapezoids and Octagons

Length In Inches	Width In Inches						
	24	30	36	42	48	54	60
36	580	615	658	705	745	784	823
42	601	642	689	740	784	829	878
48	620	668	723	776	823	874	927
54	641	692	751	807	862	919	974
60	663	719	783	842	901	969	1027
66	684	745	814	879	945	1013	1073
72	705	768	842	915	987	1057	1130

All fabrics are not available in all widths, lengths and applications. Refer to Size Specifications on page 34 for availability.
Product Information: See page 80-81 for detailed information. Templates required on all Octagon orders. Width, length and one side are required measurements for Octagon Shades. **Trapezoid orders must be faxed in with a diagram that includes the measurements for 4 sides.** No templates are required for Trapezoid Shades.

Prelude 3/4" Blackout

PRICE GROUP 28
Trapezoids and Octagons

Length In Inches	Width In Inches						
	24	30	36	42	48	54	60
36	543	576	616	659	697	734	770
42	562	601	644	693	734	777	821
48	581	626	677	727	770	817	867
54	600	647	704	755	806	860	912
60	620	673	732	789	843	906	960
66	640	697	762	823	885	948	1004
72	659	719	789	856	924	989	1058

Product Information: See page 115-116 for detailed information. Templates required on all Octagon orders. Width, length and one side are required measurements for Octagon Shades. **Trapezoid orders must be faxed in with a diagram that includes the measurements for 4 sides.** No templates are required for Trapezoid Shades.

FABRIC SURCHARGES		ADD
Scotchgard Stain Protector		\$35
Premiere Fabric	Includes: Homespun, Country Woven, Florance, Spheres, Strata, Tuscan Scroll, Angel Hair, Blossom, and Gradients	20%
HARDWARE UPGRADE SURCHARGES AND ACCESSORIES		ADD
6 Foot Expandable Pole		\$37
12 Foot Expandable Pole		\$46

Comfortex Skylight and Greenhouse Shades Size Standards

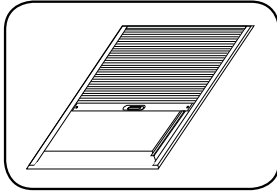

	Minimum	Balcony*	Soprano***
		0°-15° 15°-75° 75°-90°**	Skylight/Greenhouse Mezzo
ALL FABRICS (except ¼" Prelude)	Min Width	15"	11" 18"
	Min Length	12"	11" 12"
Prelude ¼"	Min Width	18"	
	Min Length	12"	

Light Filtering	Price Group Page	Max Width & Length	Balcony			Soprano Skylight/ Greenhouse	Price Group Page	Mezzo	Price Group Page
			0°-15°	15°-75°	75°-90°				
Verona ¼"	Grid 30 Page 43	Max Width & Length	NA	NA	NA	NA	Grid 29 Page 42	48" x 72"	Grid 32 Page 45
Boutique ¼"			NA	NA	NA	NA		48" x 72"	
Debut ½" Double			NA	NA	NA	NA		48" x 72"	
Debut ½" Single			36" x 96"	48" x 96"	48" x 72"	36" x 144" SL 29" x 180"GH		48" x 72"	
Debut ¾"			NA	NA	NA	NA		48" x 72"	
Linen Weave ¾"			NA	NA	NA	NA		48" x 72"	
Premiere ½"			NA	NA	NA	NA		48" x 72"	
Premiere ¾"			NA	NA	NA	NA		48" x 72"	
Symphony ¾"			36" x 96"	48" x 96"	48" x 72"	48" x 144" SL 36" x 180"GH	48" x 72"		
Prelude ¼"	34 Pg47	Max Width & Length	60" x 72" 25 sqft						

Room Darkening & Blackout	Price Group Page	Max Width & Length	Balcony			Soprano Skylight/ Greenhouse	Price Group Page	Mezzo	Price Group Page
			0°-15°	15°-75°	75°-90°				
Verona ¼"	Grid 31 Page 44	Max Width & Length	NA	NA	NA	NA	Grid 29 Page 42	48" x 72"	Grid 33 Page 46
Boutique ¼"			NA	NA	NA	NA		48" x 72"	
Linen Weave ¾"			NA	NA	NA	NA		48" x 72"	
Premiere ½"			NA	NA	NA	NA		48" x 72"	
Premiere ¾"			NA	NA	NA	NA		48" x 72"	
Symphony ¾"			36" x 96"	48" x 96"	48" x 72"	NA	48" x 72"		
Prelude ¼"	35 Pg47		60" x 72" 25 sqft						

More Information On Page	Page 84	Page 82	Page 86
--------------------------	---------	---------	---------

*Total Balcony shade area not to exceed 24 square feet. **Total Balcony shade area not to exceed 18 square feet. Balcony shades can be mounted on their side. Use vertical measurement as your width (max 36") and the horizontal measurement as your length (max 48"). ***Soprano Skylight minimum installation angle of 5 degrees. Maximum installation angle of 85 degrees. Horizontal (0 degrees) and vertical (90 degrees) applications are not recommended. ***All Soprano Greenhouse shade orders require a completed and signed greenhouse shade order form. Orders must be faxed to Comfortex for processing. Download a copy of the order form at www.comfortex.com/comfortex-dealers.

LIGHT FILTERING FABRICS

Debut 1/2" Single Cell
Symphony 3/8"

PRICE GROUP 29

Soprano Skylights and Greenhouses

Specialty Shaped Shades

		Width In Inches					
		26	30	34	38	42	48
Length In Inches	30	499	532	567	599	632	670
	36	540	578	615	652	689	728
	42	580	624	663	704	747	789
	48	624	670	715	756	801	851
	54	663	718	763	809	856	909
	60	707	763	812	863	911	969
	72	792	850	909	968	1026	1093
	84	877	943	1012	1075	1139	1215
	96	965	1035	1109	1180	1254	1340
	108	1050	1129	1205	1283	1362	1456
	120	1139	1219	1307	1392	1477	1579
	132	1221	1313	1405	1497	1590	1698
	144	1300	1406	1505	1605	1701	1822
	156	1383	1499	1605	1710		
168	1465	1594	1704	1815			
180	1545	1689	1801	1920			

All fabrics are not available in all widths, lengths and applications. Refer to Size Specifications on page 42 for availability.
Product Information: See page 82 for detailed information. All greenhouse orders require a completed and signed greenhouse shade order form. Orders must be mailed or faxed to Comfortex for processing. Download a copy at www.comfortex.com or from the OnDemand Mobile Library.

FABRIC SURCHARGES		ADD
Scotchgard Stain Protector		\$35
Debut 1/2" Single Cell Print Fabric	Includes: Homespun, Country Woven, Florance, Strata, Angel Hair, Blossom, Terrazzo and Strie	20%
Symphony Fabric	Symphony Prints and Duotones	20%
	Symphony Double Cell Flame Resistant	30%
HARDWARE UPGRADE SURCHARGES* AND ACCESSORIES		ADD
Two Moving Rails		\$129
6 Foot Expandable Pole		\$37
12 Foot Expandable Pole		\$46

Rail Colors Available:

Please specify when ordering

- White head and bottom rail with white geartrack retainer.
- Bronze head and bottom rails and bronze geartrack retainer.

LIGHT FILTERING FABRICS

Debut 1/2" Single Cell
Symphony 3/8"

PRICE GROUP 30
Balcony Skylight Shading System

		Width In Inches				
		24	30	36	42	48
Length In Inches	36	319	363	405	454	494
	42	337	386	440	488	542
	48	354	414	466	523	581
	54	379	439	498	556	631
	60	392	464	527	591	677
	66	414	486	555	621	721
	72	439	513	579	648	761
	78	464	532	606	677	
	84	490	558	632	704	
	90	522	579	659		
96	547	603	686			

All fabrics are not available in all widths, lengths and applications. Refer to Size Specifications on page 42 for availability.

Product Information: See page 84 for detailed information.

- Shades are built with color coordinating hardware and white track.
- Designer metallic and fabric wrapped rails are available.

FABRIC SURCHARGES		ADD
Scotchgard Stain Protector		\$35
Debut 1/2" Single Cell Print Fabric	Includes: Homespun, Country Woven, Florance, Strata, Angel Hair, Blossom, Terrazzo and Strie	20%
Symphony Fabric	Symphony Prints and Duotones	20%
	Symphony Double Cell Flame Resistant	30%
HARDWARE UPGRADE SURCHARGES AND ACCESSORIES		ADD
Metallic Hardware or Fabric Wrapped Rails		\$22
6 Foot Expandable Pole		\$37
12 Foot Expandable Pole		\$46

BLACKOUT FABRICS

Symphony 3/8"

PRICE GROUP 31
Balcony Skylight Shading System

Specialty Shaped Shades

		Width In Inches				
		24	30	36	42	48
Length In Inches	36	415	472	527	590	642
	42	438	502	572	634	705
	48	460	538	606	680	755
	54	493	571	647	723	820
	60	510	603	685	768	880
	66	538	632	722	807	937
	72	571	667	753	842	989
	78	603	692	788	880	
	84	637	725	822	915	
	90	679	753	857		
96	711	784	892			

- Product Information:** See page 84 for detailed information.
- Shades are built with color coordinating hardware and white track.
 - Designer metallic and fabric wrapped rails are available.

FABRIC SURCHARGES		ADD
Scotchgard Stain Protector		\$35
Debut 1/2" Single Cell Print Fabric	Includes: Homespun, Country Woven, Florance, Strata, Angel Hair, Blossom, Terrazzo and Strie	Add 20%
Symphony Fabric	Symphony Prints and Duotones	Add 20%
	Symphony Double Cell Flame Resistant	Add 30%
HARDWARE UPGRADE SURCHARGES AND ACCESSORIES		ADD
Metallic Hardware or Fabric Wrapped Rails		\$22
6 Foot Expandable Pole		\$37
12 Foot Expandable Pole		\$46

LIGHT FILTERING FABRICS

Boutique 3/4"
 Debut 1/2" Single Cell
 Debut 1/2" Double Cell
 Debut 3/4" Single Cell
 Linen Weave 3/4"

Premiere 1/2"
 Premiere 3/4"
 Symphony 3/8"
 Verona 3/4"

PRICE GROUP 32
Mezzo Motorized Skylights -
White Rail and White Tracks

		Width In Inches				
		24	30	36	42	48
Length In Inches	36	398	453	506	568	617
	42	422	482	549	609	678
	48	445	518	583	653	727
	54	472	548	623	695	787
	60	490	579	658	739	845
	66	518	606	692	778	901
72	548	642	723	809	952	

Be sure to add the Simplicity motor surcharges and upgrades to the grid above. Shades and motors are priced separately to ensure that percent surcharges apply only to the shade and not the motor.

Product Information: See page 86 for detailed information.

- Mezzo Shades are built with white rail and white track.

FABRIC SURCHARGES		ADD
Scotchgard Stain Protector		\$35
Debut 1/2" Single Cell Print Fabric	Includes: Homespun, Country Woven, Florance, Strata, Angel Hair, Blossom, Terrazzo and Strie	20%
Debut 1/2" Double Cell Print Fabric Debut 3/4" Single Cell Print Fabric	Includes: Homespun, Country Woven, Florance, Strata and Angel Hair	20%
Premiere Fabric	Includes: Homespun, Country Woven, Florance, Spheres, Strata, Tuscan Scroll, Angel Hair, Blossom, and Gradients	20%
Symphony Fabric	Symphony Prints and Duotones	20%
	Symphony Double Cell Flame Resistant	30%
MOTORIZATION - HARDWARE UPGRADE SURCHARGES AND ACCESSORIES		MORE INFO
Simplicity - Motor and Rechargeable Battery Pack		Pg 61
Simplicity 5 Channel Remote		\$334
Simplicity 6 Channel Remote		\$40
Simplicity 6 Channel Remote with Timer		\$65
48" Extension Wire:		Pg 61
Simplicity Smart Controller (NEO)		\$18
7.4v Solar Panel & Mounting Brackets		Pg 68
Plug-In Charger for 7.4V Li-Ion Rechargeable Battery Pack		\$330
		Pg 87
		\$75
		Pg 87
		\$54

ROOM DARKENING & BLACKOUT FABRICS

Boutique 3/4"
 Linen Weave 3/4"
 Premiere 1/2"

Premiere 3/4"
 Symphony 3/8"
 Verona 3/4"

PRICE GROUP 33
Mezzo Motorized Skylights -
White Rail and White Tracks

Specialty Shaped Shades

		Width In Inches				
		24	30	36	42	48
Length In Inches	36	517	589	658	738	802
	42	549	627	714	792	881
	48	579	673	758	849	945
	54	614	712	810	904	1023
	60	637	753	855	961	1099
	66	673	788	900	1011	1171
	72	712	835	940	1052	1238

Be sure to add the Simplicity motor surcharges and upgrades to the grid above.

Product Information: See page 86 for detailed information.

- Mezzo Shades are built with white rail and white track.

FABRIC SURCHARGES		ADD	
Scotchgard Stain Protector		\$35	
Premiere Fabric	Includes: Homespun, Country Woven, Florance, Spheres, Strata, Tuscan Scroll, Angel Hair, Blossom, and Gradients	Add 20%	
MOTORIZATION - HARDWARE UPGRADE SURCHARGES AND ACCESSORIES		MORE INFO	ADD
Simplicity - Motor and Rechargeable Battery Pack		Pg 61	\$334
Simplicity 5 Channel Remote		Pg 61	\$40
Simplicity 6 Channel Remote with Timer		Pg 61	\$65
48" Extension Wire:		Pg 61	\$18
Simplicity Smart Controller (NEO)		Pg 68	\$330
7.4v Solar Panel & Mounting Brackets		Pg 87	\$75
Plug-In Charger for 7.4V Li-Ion Rechargeable Battery Pack		Pg 87	\$54

Prelude 3/4" Light Filtering

PRICE GROUP 34
Skylight Shading System

		Width In Inches						
		24	30	36	42	48	54	60
Length In Inches	36	288	327	365	409	445	512	589
	42	304	348	396	440	488	562	647
	48	319	373	420	471	523	602	693
	54	342	396	449	501	568	654	753
	60	353	418	475	532	610	702	808
	66	373	438	500	559	649	747	860
	72	396	462	522	584	685	788	907

Prelude 3/4" Blackout

PRICE GROUP 35
Skylight Shading System

		Width In Inches						
		24	30	36	42	48	54	60
Length In Inches	36	389	442	493	553	601	692	796
	42	411	470	535	594	659	759	874
	48	431	504	567	636	707	813	936
	54	462	535	607	677	767	883	1017
	60	477	565	642	719	824	948	1091
	66	504	592	675	755	877	1009	1161
	72	535	624	705	789	925	1064	1225

Product Information: See page 117 for detailed information.

HARDWARE UPGRADE SURCHARGES AND ACCESSORIES		ADD
5 Foot Expandable Pole		\$37

Prelude Cellular Shades

French Door Décor Shades Size Standards

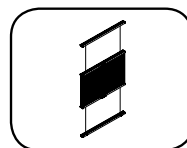
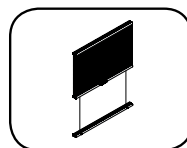

		Door Decor Non-Movable	Door Decor Movable	Door Decor Top Down-Bottom Up
ALL FABRICS	Minimum Width	6"	6"	6"
	Minimum Length	12"	12"	12"

Light Filtering	Price Group	Page		Door Decor Non-Movable	Door Decor Movable	Price Group Page	Door Decor Top Down-Bottom Up	Price Group Page
Verona 3/4"	36	49	Maximum Width & Length	36" x 96"	36" x 96"	37 Page 50	36" x 96"	37 Page 50
Boutique 3/4"				36" x 96"	36" x 96"		36" x 96"	
Debut 1/2" Single				36" x 96"	36" x 96"		36" x 96"	
Debut 1/2" Double				36" x 96"	36" x 96"		36" x 96"	
Debut 3/4"				36" x 96"	36" x 96"		36" x 96"	
Linen Weave 3/4"				36" x 96"	36" x 96"		36" x 96"	
Premiere 1/2"				36" x 96"	36" x 96"		36" x 96"	
Premiere 3/4"				36" x 96"	36" x 96"		36" x 96"	
Symphony 3/8"				36" x 96"	36" x 96"		36" x 96"	

Room Darkening & Blackout	Price Group	Page		Door Decor Non-Movable	Door Decor Movable	Price Group Page	Door Decor Top Down-Bottom Up	Price Group Page
Verona 3/4"	38	51	Maximum Width & Length	36" x 96"	36" x 96"	39 Page 52	36" x 96"	39 Page 52
Boutique 3/4"				36" x 96"	36" x 96"		36" x 96"	
Linen Weave 3/4"				36" x 96"	36" x 96"		36" x 96"	
Premiere 1/2"				36" x 96"	36" x 96"		36" x 96"	
Premiere 3/4"				36" x 96"	36" x 96"		36" x 96"	
Symphony 3/8"				36" x 96"	36" x 96"		36" x 96"	

		Door Decor Non-Movable	Door Decor Movable	Door Decor Top Down-Bottom Up
More Information On Page		Page 89	Page 89	Page 89

LIGHT FILTERING FABRICS

- Boutique 3/4"
- Debut 1/2" Single Cell
- Debut 1/2" Double Cell
- Debut 3/4" Single Cell
- Linen Weave 3/4"
- Premiere 1/2"
- Premiere 3/4"
- Symphony 3/8"
- Verona 3/4"

PRICE GROUP 36
Non-Movable French Door Décor

		Width In Inches		
		24	30	36
Length In Inches	36	102	115	131
	42	109	125	140
	48	116	134	153
	54	123	141	164
	60	132	152	174
	66	139	162	187
	72	145	169	197
	78	153	179	206
	84	159	188	217
	90	166	196	227
96	171	203	238	

Product Information: See page 87 for detailed information.

FABRIC SURCHARGES		ADD
Scotchgard Stain Protector		\$35
Debut 1/2" Single Cell Print Fabric	Includes: Homespun, Country Woven, Florance, Strata, Angel Hair, Blossom, Terrazzo and Strie	20%
Premiere Fabric	Includes: Homespun, Country Woven, Florance, Spheres, Strata, Tuscan Scroll, Angel Hair, Blossom, and Gradients	20%
Symphony Fabric	Symphony Prints and Duotones	20%
	Symphony Double Cell Flame Resistant	30%
HARDWARE UPGRADE SURCHARGES AND ACCESSORIES		ADD
Metallic Hardware or Fabric Wrapped Rails		\$22
6 Foot Expandable Pole		\$37
12 Foot Expandable Pole		\$46

LIGHT FILTERING FABRICS

Boutique 3/4"
 Debut 1/2" Single Cell
 Debut 1/2" Double Cell
 Debut 3/4" Single Cell
 Linen Weave 3/4"

Premiere 1/2"
 Premiere 3/4"
 Symphony 3/8"
 Verona 3/4"

PRICE GROUP 37
Movable French Door Décor

Specialty Shaped Shades

		Width In Inches		
		24	30	36
Length In Inches	36	183	206	235
	42	197	224	254
	48	209	241	275
	54	222	256	294
	60	238	273	316
	66	251	290	336
	72	263	306	354
	78	275	323	373
	84	285	337	391
	90	300	352	410
96	310	366	427	

Product Information: See page 89 for detailed information.

FABRIC SURCHARGES		ADD
Scotchgard Stain Protector		\$35
Debut 1/2" Single Cell Print Fabric	Includes: Homespun, Country Woven, Florance, Strata, Angel Hair, Blossom, Terrazzo and Strie	20%
Premiere Fabric	Includes: Homespun, Country Woven, Florance, Spheres, Strata, Tuscan Scroll, Angel Hair, Blossom, and Gradients	20%
Symphony Fabric	Symphony Prints and Duotones	20%
	Symphony Double Cell Flame Resistant	30%
HARDWARE UPGRADE SURCHARGES AND ACCESSORIES		ADD
Top Down-Bottom Up		\$166
Metallic Hardware or Fabric Wrapped Rails		\$22
6 Foot Expandable Pole		\$37
12 Foot Expandable Pole		\$46

ROOM DARKENING & BLACKOUT

Boutique 3/4"
 Linen Weave 3/4"
 Premiere 1/2"

Premiere 3/4"
 Symphony 3/8"
 Verona 3/4"

PRICE GROUP 38
Non-Movable French Door Décor

		Width In Inches		
		24	30	36
Length In Inches	36	133	150	170
	42	142	163	182
	48	151	174	199
	54	160	183	213
	60	172	198	226
	66	181	211	243
	72	189	220	256
	78	199	233	268
	84	207	244	282
	90	216	255	295
96	222	264	309	

Product Information: See page 89 for detailed information.

FABRIC SURCHARGES		ADD
Scotchgard Stain Protector		\$35
Premiere Fabric	Includes: Homespun, Country Woven, Florance, Spheres, Strata, Tuscan Scroll, Angel Hair, Blossom, and Gradients	20%
Symphony Fabric	Symphony Prints and Duotones	20%
	Symphony Double Cell Flame Resistant	30%
HARDWARE UPGRADE SURCHARGES AND ACCESSORIES		ADD
Metallic Hardware or Fabric Wrapped Rails		\$22
6 Foot Expandable Pole		\$37
12 Foot Expandable Pole		\$46

ROOM DARKENING & BLACKOUT

Boutique 3/4"
 Linen Weave 3/4"
 Premiere 1/2"

Premiere 3/4"
 Symphony 3/8"
 Verona 3/4"

PRICE GROUP 39
Movable French Door Décor

Specialty Shaped Shades

		Width In Inches		
		24	30	36
Length In Inches	36	238	268	306
	42	256	291	330
	48	272	313	358
	54	289	333	382
	60	309	355	411
	66	326	377	437
	72	342	398	460
	78	358	420	485
	84	371	438	508
90	390	458	533	
96	403	476	555	

Product Information: See page 89 for detailed information.

FABRIC SURCHARGES		ADD
Scotchgard Stain Protector		\$35
Premiere Fabric	Includes: Homespun, Country Woven, Florance, Spheres, Strata, Tuscan Scroll, Angel Hair, Blossom, and Gradients	20%
Symphony Fabric	Symphony Prints and Duotones	20%
	Symphony Double Cell Flame Resistant	30%
HARDWARE UPGRADE SURCHARGES AND ACCESSORIES		ADD
Top Down-Bottom Up		\$166
Metallic Hardware or Fabric Wrapped Rails		\$22
6 Foot Expandable Pole		\$37
12 Foot Expandable Pole		\$46

Cellular Shade Head Rail Options

STANDARD CORD LOCK SHADES | Prelude Hardware Page 94

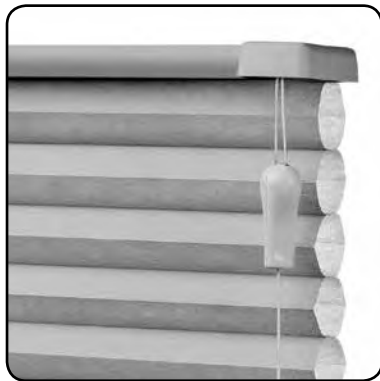

Standard Cord Lock Rail

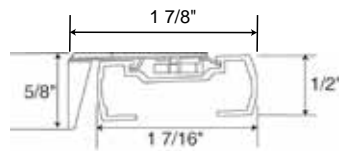

Deluxe Cord Lock Rail

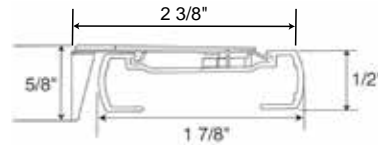

Standard Cord Lock Rail

- Depth of rail: 1 7/16"
- Depth of rail and bracket: 1 7/8"
- Height of rail: 1/2"
- Height of bracket: 5/8"

Deluxe Cord Lock Rail

- Depth of rail: 1 7/8"
- Depth of rail and bracket: 2 3/8"
- Height: 1/2"
- Height of bracket: 5/8"

Hardware Features		
Hardware colors for all Cellular fabrics	Color coordinated head and bottom rails with white cord and tassel	
Standard Hardware for all Custom Graphics	White head and bottom rails with white cord and tassel	
Upgrades		
Fabric Wrapped Upgrade	Fabric used is same fabric as the shade. Back of rail is white to outside. Color coordinated end caps.	
Designer Metallic Upgrade	<ul style="list-style-type: none"> • Oil Rubbed Bronze head and bottom rails with bronze colored tassel, end caps and white cord. • Brushed Nickel head and bottom rails and end caps with white cord. 	
Mounting Dimensions		
	Standard Cord Lock Rail	Deluxe Cord Lock Rail
Minimum Shallow Mount	3/4"	3/4"
Minimum Flush Inside Mount	2"	2 3/8"
Minimum Outside Mount	3/4"	3/4"
Minimum Side Mount	1 1/8"	1 3/8"
Minimum Flush Side Mount	1 5/8"	1 7/8"
Recommended Side Mounting Method	<ul style="list-style-type: none"> • See figure B for recommended mounting method for side mount shades • Width limit for side mount brackets is 48" 	
Finished Dimensions		
Inside and Side Mount		
	<ul style="list-style-type: none"> • Fabric will measure ordered width less: 3/8" • Head rail* will measure ordered width less: 3/16" 	
Outside Mount		
	<ul style="list-style-type: none"> • Fabric will measure ordered width • Head rail* will measure ordered width plus: 3/16" 	
Exact (End Cap to End Cap) Mount		
	<ul style="list-style-type: none"> • Fabric will measure ordered width less: 3/16" • Head rail* will measure ordered width 	
* Head rail measurements include endcaps. Width and length measurements may vary +/- 1/8"		

Cellular Shade

STANDARD CORD LOCK SHADES | *Prelude Hardware Page 94*

There are two sizes of the cord lock hardware: **Standard and Deluxe.**

Standard size hardware is used on all fabrics except ¾" Premiere, Linen Weave, Debut, Verona and Boutique Fabrics which use the Deluxe size.

- Standard Rectangular
- Two-On-One Head Rail
- Door Decor
- SlumberShades
- Top Down - Bottom Up
- Day-Night
- Specialty Shapes
- Balcony

Deluxe Hardware is standard on ¾" Premiere, Linen Weave, Debut, Verona and Boutique Fabrics.

- Standard Rectangular
- SlumberShades
- Two-On-One Head Rail
- Top Down - Bottom Up
- Specialty Shapes

Highlights Cornice Valance

Add a designer finishing touch to a cellular shade with a Highlights Cornice Valance. See page 118 for details.

Recommended Mounting Method for Side Mount Shades | Maximum Width 48"

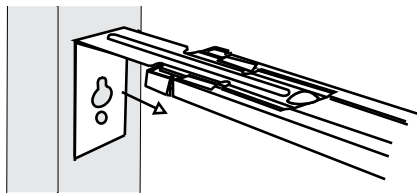

Figure B

EZ Level on Cellular Shades

EZ Level makes quick work of leveling without cords to cut or tuck into a rail. See page 119 for details.

Things to Consider

- If child safety is a concern, consider cordless options: Cordless Ultra, Cordless Lift & Lock or Motorization.
- Larger shades can be difficult to operate. Consider Cord Loop, Cordless Ultra or Motorization hardware.
- If privacy is an issue, consider Top Down-Bottom Up options.

Ordering Information Standard Cord Lock Shades

Standard Rectangular

- Specify IB or OB mount, rail color and left or right lift cord.

Top Down - Bottom Up

- Specify IB or OB mount and rail color. Middle rail will match the head and bottom rails.
- Top Down - Bottom Up Shades are made with two operating cord locks, one on the left and one on the right side of shade. The right cord operates the middle rail and left cord operates the bottom.

Two-On-One Head Rail

Two-On-One Head Rail Shades operate as two separate shades on one head rail.

- Specify IB or OB mount.
- Specify panel sizes.
- Maximum width in a single panel depends on fabric type. See page 11 for maximum single panel width.
- ⅜" Space between panels.
- Fabric wrapped Two-On-One Shades will have a seam in the center of the rail due to the wide width.

Specialties (Arches, Trapezoids, Octagons and Quarter Rounds)

See pages 75-79 for more information.

Balcony Skylight Shading System

See pages 84-85 for more information.

Door Decor

See pages 89-90 for more information.

Insulating SlumberShades

See pages 73-74 for more information.

Day-Night Shades

See pages 91-92 for more information.

Cellular Shade Head Rail Options

CORD LOOP HARDWARE SYSTEM | Prelude Hardware Page 96

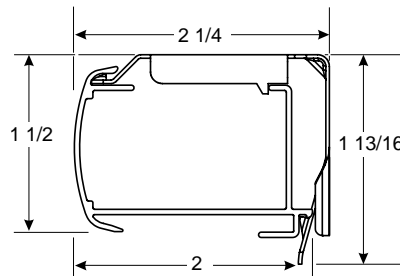

Cord Loop Rail Dimensions

- Depth of rail: 2"
- Depth of rail and bracket: 2 1/4"
- Height of rail: 1 1/2"
- Height of bracket: 1 13/16"

Hardware Features	
Hardware colors for all Cellular and Pleated fabrics	Color coordinated head, bottom rails and end caps with a white cord and tensioner
Standard Hardware for all Custom Graphics	White head and bottom rails with white cord
Upgrades	
Fabric Wrapped Upgrade	Fabric used is same fabric as the shade. Back of rail is white to outside. Color coordinated end caps for bottom rails, head rail has white clutch cover and end caps.
Designer Metallic Upgrade	<ul style="list-style-type: none"> • Smooth faced Oil Rubbed Bronze head, bottom rails and end caps with bronze tensioner and bronze cord. • Smooth faced Brushed Nickel head, bottom rails and end caps with silver tensioner and silver cord.

Mounting Dimensions	Cord Loop Hardware System
Minimum Shallow Mount	1/2"
Minimum Flush Inside Mount	2 1/4"
Minimum Outside Mount	7/8"
Minimum Side Mount	1 1/4"
Minimum Flush Side Mount	2 1/4"
Recommended Side Mounting Method	<ul style="list-style-type: none"> • See figure A for recommended mounting method for side mount shades • Width limit for side mount brackets is 48"

Finished Dimensions	
Inside Mount	
	<ul style="list-style-type: none"> • Fabric will measure ordered width less: 3/8" • Head rail* will measure ordered width less: 3/16"
Outside Mount	
	<ul style="list-style-type: none"> • Fabric will measure ordered width • Head rail* will measure ordered width plus: 3/16"
Side Mount	
	<ul style="list-style-type: none"> • Fabric will measure ordered width less: 7/8" • Head rail* will measure ordered width less: 1 1/16"
Exact (End Cap to End Cap) Mount	
	<ul style="list-style-type: none"> • Fabric will measure ordered width less: 3/16" • Head rail* will measure ordered width

* Head rail measurements include endcaps. Width and length measurements may vary +/- 1/16"

Cellular Shade

CORD LOOP HARDWARE SYSTEM | *Prelude Hardware Page 96*

Applications

- Standard Rectangular
- Two-On-One Head Rail
- Top Down - Bottom Up
- SlumberShades

Cord Loop Hardware System Features

Cord loops are available 2' to 15' lengths in 1' intervals. Please specify length when ordering. Standard loop sizes are as follows:

Shade Length	Standard Loop
Up to and including 26 ⁷ / ₈ "	1' (12")
27" to 39 ⁷ / ₈ "	2' (24")
40" to 59 ⁷ / ₈ "	3' (36")
60" to 83 ⁷ / ₈ "	4' (48")
84" to 107 ⁷ / ₈ "	5' (60")
108" and greater	6' (72")

Recommended Mounting Method for Side Mounting Shades

Width limit for side mount brackets is 48".

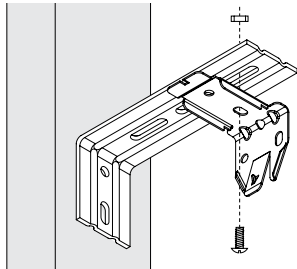

Cord Loop Hardware
Cordless Ultra Hardware
Cordless Ultra Top Down - Bottom Up Hardware

Figure A

Refer to the installation instructions on Comfortex.com/comfortex-dealers or the OnDemand Mobile Library for further details on side mounting shades.

Ordering Information for Cord Loop Hardware Shades

Standard Rectangular

- Specify IB or OB mount, rail color and left or right lift cord.
- Specify cord loop length when ordering.

Top Down - Bottom Up

- Specify IB or OB mount and rail color. Middle rail will match the top and bottom rails.
- Specify cord loop length when ordering.
- Controls are the right cord loop operates the middle rail and left cord loop operates the bottom. Reverse controls are not available.

Two-On-One Head Rail

- Two-On-One Head Rail Shades operate as two separate shades on one head rail.
- Specify IB or OB mount and rail color.
- Specify panel sizes.
- Specify cord loop length when ordering.
- Maximum width in a single panel depends on fabric type. See page 11 for maximum single panel width.
- ³/₈" Space between panels.
- Fabric wrapped Two-On-One Shades will have a seam in the center of the rail due to the wide width.

Insulating SlumberShades

See pages 73-74 for more information.

EZ Level on Cellular Shades

EZ Level makes quick work of leveling without cords to cut or tuck into a rail. See page 119 for details.

Cellular Shade Head Rail Options

CORDLESS ULTRA HARDWARE SYSTEM | Prelude Hardware Page 98

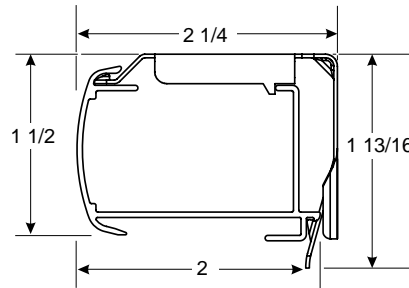

Cord Loop Rail Dimensions

- Depth of rail: 2"
- Depth of rail and bracket: 2 1/4"
- Height of rail: 1 1/2"
- Height of bracket: 1 13/16"

Hardware

Hardware Features	
Hardware colors for all Cellular fabrics (Symphony Blackout Not Available)	Color coordinated head, bottom rails and end caps
Standard Hardware for all Custom Graphics	White head, bottom rails and end caps
Upgrades	
Fabric Wrapped Upgrade	Fabric used is same fabric as the shade. Back of rail is white to outside. End caps on fabric wrapped head and bottom rails are color coordinated
Designer Metallic Upgrade	<ul style="list-style-type: none"> • Smooth faced Oil Rubbed Bronze head, bottom rails and end caps • Smooth faced Brushed Nickel head, bottom rails and end caps
Mounting Dimensions	
Cord Loop Hardware System	
Minimum Shallow Mount	1/2"
Minimum Flush Inside Mount	2 1/4"
Minimum Outside Mount	7/8"
Minimum Side Mount	1 1/4"
Minimum Flush Side Mount	2 1/4"
Recommended Side Mounting Method	<ul style="list-style-type: none"> • See figure A on page 56 for recommended mounting method for side mount shades • Width limit for side mount brackets is 48"
Finished Dimensions	
Inside Mount	
	<ul style="list-style-type: none"> • Fabric will measure ordered width less: 3/8" • Head rail* will measure ordered width less: 3/16"
Outside Mount	
	<ul style="list-style-type: none"> • Fabric will measure ordered width • Head rail* will measure ordered width plus: 3/16"
Side Mount	
	<ul style="list-style-type: none"> • Fabric will measure ordered width less: 7/8" • Head rail* will measure ordered width less: 1 1/16"
Exact (End Cap to End Cap) Mount	
	<ul style="list-style-type: none"> • Fabric will measure ordered width less: 3/16" • Head rail* will measure ordered width
* Head rail measurements include endcaps. Width and length measurements may vary +/- 1/8"	

Cellular Shade

CORDLESS ULTRA HARDWARE SYSTEM | Prelude Hardware Page 98

Applications

- Standard Rectangular
- Top Down - Bottom Up
- Insulating SlumberShades
- Two-On-One Head Rail

Highlights Cornice Valance

Add a designer finishing touch to a cellular shade with a Highlights Cornice Valance. See page 118 for details.

Things to Consider

- Is the top of your window out of reach? You can order an extension pole to reach but it can still be tricky. You may want to consider Cord Loop or Motorized hardware.
- For shades mounted on doors, you may want to order hold down brackets.
- If privacy is an issue, consider Top Down-Bottom Up options.

Ordering Information for Cordless Ultra Hardware Shades

Standard Rectangular

- Specify IB or OB mount and rail color.

Top Down - Bottom Up

- Specify IB or OB mount and rail color. Middle rail will match the head and bottom rails.

Insulating SlumberShades

See pages 73-74 for more information.

Accessories

- 6' Expandable Pole: \$37.00
- 12' Expandable Pole: \$46.00

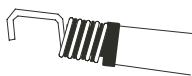

Specially designed pole end fits into the handle on the bottom rail and allows for easy operation.

Cordless Ultra and Cordless Ultra Top Down - Bottom Up Hardware Features

- Children and pets have safer surroundings in homes that have window shades without operating cords, reducing the risk of strangulation.
- Cordless Ultra and Cordless Ultra Top Down - Bottom Up Shades can be raised or lowered with a gentle push or pull on the rail handle.
- Cordless Ultra Top Down - Bottom Up Shades feature two moving rails.
- Order an operating pole for out of reach applications.

Cordless Ultra Shade Operation

Cordless shades should be operated from the handle located in the center of the bottom rail. Using the handle will aid in smooth and easy shade operation. Two handles are supplied on wider width shades.

To lower the shade, pull down on the handle which is secured to the bottom rail and guide the rail to desired position (Figure A). For out of reach applications, an optional extension pole should be used.

To raise the shade, push the bottom rail up using the handle on the bottom rail and guide the rail to the desired position. The shade will hold any position when the bottom rail is released. Raise the shade slowly and steadily to allow the shade to stack evenly (Figure B).

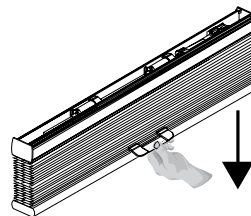

Figure A

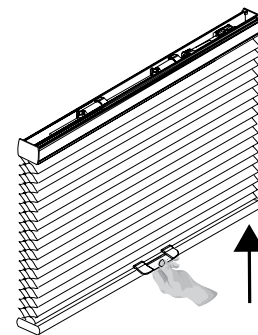

Figure B



Clear Cordless Handle

Recommended Mounting Method for Side Mounting Shades

See Page 56.

EZ Level on Cellular Shades

EZ Level makes quick work of leveling without cords to cut or tuck into a rail. See page 119 for details.

Cellular Shade Head Rail Options

CORDLESS LIFT & LOCK SHADES | Prelude Hardware Page 100



Standard Head Rail

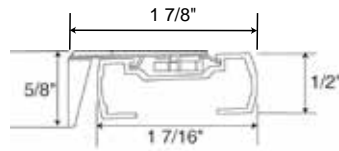

Deluxe Head Rail

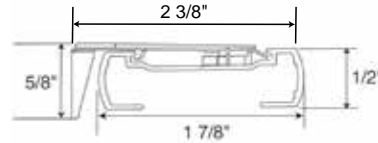

Standard Top Rail

- Depth of rail: 1 7/16"
- Depth of rail and bracket: 1 7/8"
- Height of rail: 1/2"
- Height of bracket: 5/8"

Deluxe Top Rail

- Depth of rail: 1 7/8"
- Depth of rail and bracket: 2 3/8"
- Height: 1/2"
- Height of bracket: 5/8"

Hardware Features

Hardware colors for all Cellular fabrics	Color coordinated head, middle and bottom rails with color coordinated push button/handle on the middle or bottom rails
Standard Hardware for all Custom Graphics	White head, middle and bottom rails with white cord

Upgrades

Fabric Wrapped Upgrade	Fabric used is same fabric as the shade. Back of rail is white to outside. All shades will have a color coordinated push button and handle on the middle /bottom rail. Color coordinated end caps.
Designer Metallic Upgrade	<ul style="list-style-type: none"> • Oil Rubbed Bronze head, middle, bottom rails and end caps. • Oil Rubbed Bronze push button/handle on the middle or bottom rails.

Mounting Dimensions	Standard Head Rail	Deluxe Head Rail
Minimum Shallow Mount	3/4"	3/4"
Minimum Flush Inside Mount	2"	2 1/2"
Minimum Outside Mount	3/4"	3/4"
Minimum Side Mount	1 1/8"	1 3/8"
Minimum Flush Side Mount	1 5/8"	1 7/8"
Recommended Side Mounting Method	<ul style="list-style-type: none"> • See figure A (pg 54) for recommended mounting method for side mount shades • Width limit for side mount brackets is 48" 	

Finished Dimensions

Inside and Side Mount

	<ul style="list-style-type: none"> • Fabric will measure ordered width less: 3/8" • Head rail* will measure ordered width less: 3/16"
--	---

Outside Mount

	<ul style="list-style-type: none"> • Fabric will measure ordered width • Head rail* will measure ordered width plus: 3/16"
--	--

Exact (End Cap to End Cap) Mount

	<ul style="list-style-type: none"> • Fabric will measure ordered width less: 3/16" • Head rail* will measure ordered width
--	--

* Head rail measurements include endcaps. Width and length measurements may vary +/- 1/8"

Cellular Shade

CORDLESS LIFT & LOCK SHADES | Prelude Hardware Page 100

Cordless Lift & Lock Shades Hardware System Bottom Rail Dimensions

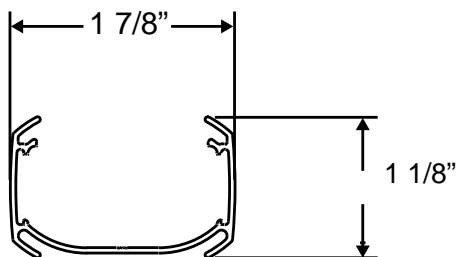

- Depth of rail: 1 7/8"
- Height of rail: 1 1/8"

Applications

- Standard Rectangular
- Top Down-Bottom Up

Standard size head rail hardware is used on 1/2" and 3/8" fabrics. These fabrics include: 1/2" Debut (all), Natural Linen Flax, 1/2" Premiere, Symphony, Symphony Blackout, Virtuoso, Virtuoso Blackout.

Deluxe size head rail hardware is used on 3/4" Premiere, Linen Weave, Verona, Boutique and 3/4" Debut and Baritone fabrics.

The bottom rail is the same size for all fabrics.

Highlights Cornice Valance

Add a designer finishing touch to a cellular shade with a Highlights Cornice Valance. See page 118 for details.

Important Operating Note on Cordless Lift & Lock Shades

- To operate a Cordless Lift & Lock Shade, the middle or bottom rails must be accessible. An extension pole is not available for Cordless Lift & Lock Shades.

Cordless Lift & Lock Hardware Features

- Children and pets have safer surroundings in homes that have window shades without operating cords, reducing the risk of strangulation.
- Cordless Lift & Lock Shades can be raised or lowered by pressing the button located on the bottom rail and guiding the rail into the desired location.

Leveling the Bottom Rails

Each Cordless Lift & Lock Shade includes a skew adjustment leveling tool hidden in the bottom rail of each shade.

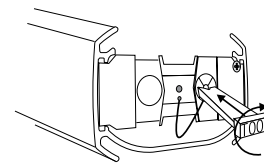

To level the bottom rail, remove the bottom rail end cap to access the tool which allows you to adjust the bottom rail. Adjustment instructions are supplied with each shade.

Things to Consider

- Is the top of your window out of reach? To operate a Cordless Lift & Lock Shade, the bottom rail must be accessible. If the bottom or middle rail is not accessible, you may want to consider Cord Loop, Cordless Ultra or Motorized hardware. An extension pole is not available for Cordless Lift & Lock Shades.
- For shades mounted on doors, you may want to order hold down brackets.

Ordering Information for Cordless Lift & Lock Shades

Standard Rectangular

- Specify IB or OB mount and rail color.

Cordless Lift & Lock Shade Operation

Cordless Lift & Lock Shades are operated using the push button handle located in the center of the bottom rail.

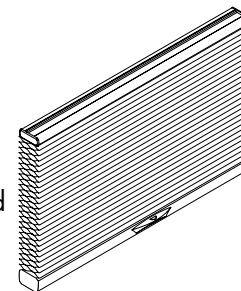

To raise or lower the shade; press the button on the shade handle, and guide the rail to desired position. Release the button to lock the shade into place.

The shade will hold any position when the button is released. Raise the shade slowly and steadily to allow the shade to stack evenly.

Cellular Shade Head Rail Options

SIMPLICITY MOTORIZED CELLULAR SHADES | *Prelude Hardware Page 102*

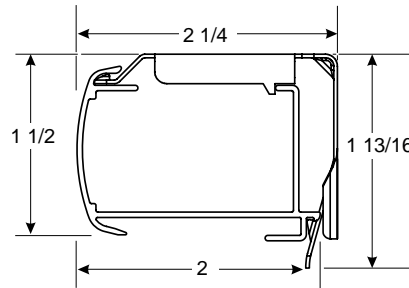

Simplicity Motorized Rail Dimensions

- Depth of rail: 2"
- Depth of rail and bracket: 2 1/4"
- Height of rail: 1 1/2"
- Height of bracket: 1 13/16"

Hardware

Hardware Features	
Hardware colors for all Cellular fabrics	Color coordinated head, bottom rails and end caps
Standard Hardware for all Custom Graphics	White head and bottom rails and end caps
Simplicity Remote	Upper and lower limit stops pre-programmed, Intermediate stop "favorites" position can be set on-site.
Upgrades	
Fabric Wrapped Upgrade	Fabric used is same fabric as the shade. Back of rail is white to outside. End caps on fabric wrapped head and bottom rails are color coordinated
Designer Metallic Upgrade	<ul style="list-style-type: none"> • Smooth faced Oil Rubbed Bronze head, bottom rails and end caps • Smooth faced Brushed Nickel head, bottom rails and end caps
Mounting Dimensions	Simplicity Motorized Hardware System
Minimum Shallow Mount	1/2"
Minimum Flush Inside Mount	2 1/4"
Minimum Outside Mount	7/8"
Minimum Side Mount	1 1/4"
Recommended Side Mounting Method	<ul style="list-style-type: none"> • See page 56 for recommended mounting method for side mount shades • Width limit for side mount brackets is 48"
Finished Dimensions	
Inside Mount	
	<ul style="list-style-type: none"> • Fabric will measure ordered width less: 3/8" • Head rail* will measure ordered width less: 3/16"
Outside Mount	
	<ul style="list-style-type: none"> • Fabric will measure ordered width • Head rail* will measure ordered width plus: 3/16"
Side Mount	
	<ul style="list-style-type: none"> • Fabric will measure ordered width less: 7/8" • Head rail* will measure ordered width less: 1 1/16"
Exact (End Cap to End Cap) Mount	
	<ul style="list-style-type: none"> • Fabric will measure ordered width less: 3/16" • Head rail* will measure ordered width
* Head rail measurements include endcaps. Width and length measurements may vary +/- 1/8"	

Cellular Shade

SIMPLICITY MOTORIZED CELLULAR SHADES | *Prelude Hardware Page 102*

Simplicity Motors

The Simplicity Motor program features a battery powered motor utilizing a single battery wand or plug-in DC transformer. Simplicity motors are compact and use a radio frequency remote to raise or lower the shades.

Motorized Lift Systems are not offered on sizes within the shaded area on the Standard Rectangular price grids.

- Length measurements may vary +/- 1/8".

Applications

- Standard Rectangular

EZ Level

Learn about the EZ Level feature on page 119.

Simplicity Motorization Surcharges

The standard Simplicity Motorized Lift System surcharge includes a 12 volt battery wand with eight AA batteries. Remotes are needed to operate the shades. See pricing pages.

Important Simplicity Motorized Shade Operating and Installation Information

- Simplicity Motorized Shades installed into windows with metal casings may have a reduced radio frequency range, or may not operate at all, depending on the application.
- Do not let the antenna on the motor touch any metal objects. This may interfere with signals from the remote control.

SIMPLICITY MOTORIZATION PRICING EXAMPLE:

Linen Weave	
Light Filtering 42" x 60" Shade:	\$364.00
Simplicity Motor Surcharge:	\$334.00
Simplicity Remote Control:	\$40.00
Total List Price:	\$738.00

Simplicity Battery Wand

Batteries are needed to operate Simplicity motors. The battery wand can be clipped to the head rail or wall or ceiling mounted utilizing white battery wand clips. The 12 volt battery wand measures 17 1/4", and comes with eight AA alkaline batteries, and is white in color.

The battery wire is 10" long. A 48" extension wire is available.



Simplicity Motor Battery Life and Replacement

Eight alkaline batteries are included with the wand.

The battery life will vary based on the type of window covering selected, the size and weight of the window covering and the number of times you operate the shade on a daily basis. For example, a 36" x 60" single honeycomb shade operated twice daily will commonly have a battery life which lasts up to 18 months.

Comfortex will warranty batteries for up to 3 months from date of purchase.

Simplicity Hand Held Remotes

The 5 Channel remote can operate up to five shades individually or 5 groups. **WHEN ORDERING PLEASE SPECIFY WHICH CHANNELS ARE ASSIGNED TO EACH SHADE OR GROUP OF SHADES.** For example; program line 1 to channel 1, line 2 and 3 to channel 2, etc. If no channels are assigned at time of order, all shades will be programmed to Channel 1. **To reprogram channel assignments, please refer to the installation instructions and/or view the video at comfortex.com/comfortex-dealers.**



Simplicity remotes and holders are black or white in color. The remote comes with a holder which can be mounted to a wall for easy storage. The range of the remote is approximately 80 feet.

The Simplicity remote utilizes one 3V battery (CR2032). Batteries are included. Comfortex will warranty batteries for up to 3 months from date of purchase.

A **6 Channel (6C) timer remote** is also available. See page 65 for more information.

DC Power Supply/Transformer

12 Volt DC power supply/transformer is available and requires a standard power outlet to power the motor. The transformer is an alternative to a battery wand. Each transformer can power a single shading. The power supply must plug in to the motor. The DC power supply is white and comes with a 80" wire. The dimensions are 1 7/8" wide x 3 1/4" long x 1 1/4" deep



Cellular Shade Head Rail Options

RECHARGEABLE SIMPLICITY MOTORIZED CELLULAR SHADES

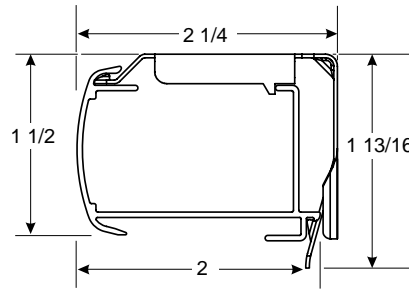

Rechargeable Simplicity Rail Dimensions

- Depth of rail: 2"
- Depth of rail and bracket: 2 1/4"
- Height of rail: 1 1/2"
- Height of bracket: 1 13/16"

Hardware Features

Hardware colors for all Cellular fabrics	Color coordinated head, bottom rails and end caps
Standard Hardware for all Custom Graphics	White head and bottom rails and end caps

Upgrades

Fabric Wrapped Upgrade	Fabric used is same fabric as the shade. Back of rail is white to outside. End caps on fabric wrapped head, middle and bottom rails are color coordinated
Designer Metallic Upgrade	<ul style="list-style-type: none"> • Smooth faced Oil Rubbed Bronze head, middle, bottom rails and end caps • Smooth faced Brushed Nickel head, middle, bottom rails and end caps

Mounting Dimensions	Rechargeable Simplicity Motorization Hardware System
---------------------	--

Minimum Shallow Mount	1/2"
Minimum Flush Inside Mount	2 1/4"
Minimum Outside Mount	7/8"
Minimum Side Mount	1 1/4"
Minimum Flush Side Mount	2 1/4"

Recommended Side Mounting Method	<ul style="list-style-type: none"> • See page 56 for recommended mounting method for side mount shades • Width limit for side mount brackets is 48"
---	---

Finished Dimensions

Inside Mount

	<ul style="list-style-type: none"> • Fabric will measure ordered width less: 3/8" • Head rail* will measure ordered width less: 3/16"
--	---

Outside Mount

	<ul style="list-style-type: none"> • Fabric will measure ordered width • Head rail* will measure ordered width plus: 3/16"
--	--

Side Mount

	<ul style="list-style-type: none"> • Fabric will measure ordered width less: 7/8" • Head rail* will measure ordered width less: 1 1/16"
--	---

Exact (End Cap to End Cap) Mount

	<ul style="list-style-type: none"> • Fabric will measure ordered width less: 3/16" • Head rail* will measure ordered width
--	--

* Head rail measurements include endcaps. Width and length measurements may vary +/- 1/8"

Cellular Shade

RECHARGEABLE SIMPLICITY MOTORIZED CELLULAR SHADES

Rechargeable Simplicity Motors

The Simplicity Motor program features a battery powered motor utilizing a rechargeable battery hidden inside the shade head rail. Simplicity motors are compact and use a radio frequency remote to raise or lower the shades.

Rechargeable Motorized Lift Systems are not offered on sizes within the shaded area on the Standard Rectangular price grids.

Applications

- Standard Rectangular

EZ Level

Learn about the EZ Level feature on page 119.

Rechargeable Simplicity Motorization Surcharges

The Rechargeable Simplicity Motorized Lift System surcharge includes a rechargeable battery. Remotes are needed to operate the shades. Refer to pricing pages.

Important Simplicity Motorized Shade Operating and Installation Information

- Simplicity Motorized Shades installed into windows with metal casings may have a reduced radio frequency range, or may not operate at all, depending on the application.
- Do not let the antenna on the motor touch any metal objects. This may interfere with signals from the remote control.

Solar Panel Recharge Option

Plugs in to any Simplicity Rechargeable Remote control shade (does not work with PowerTouch)

Provides constant trickle charge to 7.4v Li-Ion Rechargeable battery packs. Does not require direct sunlight, but performs best in regular direct sunlight applications. Will prolong the life of the charge of the 7.4v rechargeable battery packs, and in some applications will maintain charge indefinitely.

Life of charge is subject to application variables such as, size and weight of shade, frequency of use, amount of direct sunlight exposure, etc.



Dimensions of panel
18 1/2" x 1 1/2"

Simplicity Rechargeable Battery

The rechargeable battery is concealed in the head rail of the shade. A charger is required for the rechargeable battery. The rechargeable battery comes fully charged from the factory.



Charging Port on Back of Head rail.

Retrofit Existing Standard Simplicity Motorized Shades with Rechargeable Batteries

Cellular shades made with Standard Simplicity Motorization can be retrofitted with the Rechargeable Simplicity Motorization Battery Wand. The Rechargeable battery wand is 22" long, comes with 10 NiMH batteries, and is white in color. Battery wands are charged at the factory.

To retrofit the rechargeable battery wand to an existing shade with a cassette head rail, you must have at least 24" between bracket centerlines to fit the battery wand. Otherwise, the wand must be placed elsewhere along the window. Wall mounting clips are provided with the wand.

Retrofit Ordering Requirements:

- Rechargeable battery wand with clips (one per shade)
- Rechargeable battery charger (one or more per order, or as needed)
- Charge port mounting base (optional)

Please contact customer service for more information.



Battery Wand for
Rechargeable Simplicity Retrofit

RECHARGEABLE SIMPLICITY PRICING EXAMPLE:

Linen Weave	
Light Filtering 42" x 60" Shade:	\$364.00
Simplicity Rechargeable Surcharge:	\$334.00
Charger for Rechargeable :	\$27.00
Simplicity Remote Control:	\$40.00
Total List Price:	\$765.00

Cellular Shade

RECHARGEABLE SIMPLICITY MOTORIZED CELLULAR SHADES

Simplicity Rechargeable Battery Life

Rechargeable batteries are included with the motor.

The average battery charge will last 6-12 months based on an average sized shade raised and lowered once per day. The life of the battery charge will vary based on the type of window covering selected, the size and weight of the window covering and the number of times the shade is operated on a daily basis.

The battery can be recharged up to 500 times. It takes approximately 5 hours to recharge the motor when fully depleted.

Ordering Information for Rechargeable Motorized Cellular Shades

Simplicity Motor Option

- Specify IB or OB mount and rail color.
- Specify remote and other accessories if needed.
- Specify one or more battery chargers.

Please Note:

- Not all motors run at the same rate of speed.
- Simplicity motors have a "Favorites" position setting. If the homeowner wants to set several shades at the same intermediate position, follow instructions provided with installation manual.
- Simplicity Rechargeable Motorized Cellular Shades are programmed at the factory with the "up and down" limits. The shades are **UNLINKED** from the remote so they are not able to operate during shipping. Each shade should be installed **after** linking it to the remote.
- **REMEMBER: Order at least one charger if ordering rechargeable motors.**

Simplicity Motorized Shade Warranty

Please see pages 134-135 for complete Comfortex warranty information.

Battery Charger

8.4 Volt charger requires a standard power outlet to recharge the battery wand. Must specify charger when ordering a Simplicity Rechargeable Wand Shade. The charger plugs into the charger port. The charger is black and comes with a 156" wire. The dimensions are 1" wide x 2½" length x 1¾" deep.



Simplicity Motor Hand Held Remotes 5 Channel Remote

The **5 Channel (5C) remote** can operate up to five shades individually or 5 groups. Simplicity Rechargeable Motorized Cellular Shades are programmed at the factory with the "up and down" limits. The shades are **UNLINKED** from the remote so they are not able to operate during shipping. Each shade should be installed **after** linking it to the remote.

Simplicity 5C remotes and holders are white or black in color. The remote comes with a holder which can be mounted to a wall for easy storage. The range of the remote is approximately 80 feet.



6 Channel Timer Remote

The **6 Channel (6C) timer remote** combines the functionality of a six channel hand-held control with the convenience of a programmable timer.

- The 6C timer remote allows for 18 different scheduled actions.
- Manual function disables the timer so then the remote operates as a held remote.

Simplicity 6C remotes and holders are white in color. The remote comes with a holder which can be mounted to a wall for easy storage. The range of the remote is approximately 80 feet.



Simplicity Rechargeable Motorized Cellular Shades are programmed at the factory with the "up and down" limits. The shades are **UNLINKED** from the remote so they are not able to operate during shipping. Each shade should be installed **after** linking it to the remote.

Simplicity Motor Hand Held Remotes Operation

Press the up or down button on the remote to raise or lower the shade to your desired position.

To reprogram channel assignments, please refer to the installation instructions and/or view the video at: comfortex.com/comfortex-dealers.

The Simplicity remotes utilize one 3V battery. Batteries are included. Comfortex will warranty batteries for up to 3 months from date of purchase. Batteries are not covered by the warranty.

Cellular Specialty Shades

MOTORIZED TOP DOWN-BOTTOM UP CELLULAR SHADES

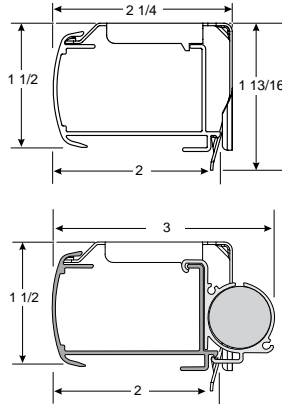

Simplicity Motorized Rail Dimensions

- Depth of rail: 2"
- Depth of rail and bracket: 2 1/4"
- Height of rail: 1 1/2"
- Height of bracket: 1 13/16"

Simplicity Motorized Rail with External Battery Dimensions

- Depth of rail: 2"
- Depth of rail, bracket & battery: 3"
- Height of rail: 1 1/2"
- Height of bracket: 1 13/16"

Hardware Features	
Standard Hardware	<ul style="list-style-type: none"> • Color coordinated head, middle, and bottom rails. Head rail and Bottom rails will have frosted end caps with fabric inserts.
14 Channel TDBU Remote	Upper and lower limit stops pre-programmed
Upgrades	
Designer Metallic Upgrade	<ul style="list-style-type: none"> • Smooth faced Designer Oil Rubbed Bronze head, middle, bottom rails and end caps • Smooth faced Designer Brushed Nickel head, middle, bottom rails and end caps
Fabric Wrapped Rails	<ul style="list-style-type: none"> • Fabric used to cover the rails is the same fabric as the shade. The back of the rail will be white to the outside. End Caps will be color coordinated.

Mounting Dimensions	Simplicity Motorized Hardware System
Minimum Shallow Mount	1/2"
Minimum Flush Inside Mount	2 1/4"
Minimum Outside Mount	7/8"
Minimum Side Mount	1 1/4"
Recommended Side Mounting Method	<ul style="list-style-type: none"> • See page 79 for recommended mounting method for side mount shades • Width limit for side mount brackets is 48"

Finished Dimensions	
Inside Mount	
	<ul style="list-style-type: none"> • Fabric will measure ordered width less: 3/8" • Head rail* will measure ordered width less: 3/16"
Outside Mount	
	<ul style="list-style-type: none"> • Fabric will measure ordered width • Head rail* will measure ordered width plus: 3/16"
Side Mount	
	<ul style="list-style-type: none"> • Fabric will measure ordered width less: 7/8" • Head rail* will measure ordered width less: 1 1/16"
Exact (End Cap to End Cap) Mount	
	<ul style="list-style-type: none"> • Fabric will measure ordered width less: 3/16" • Head rail* will measure ordered width
* Head rail measurements include endcaps. Width and length measurements may vary +/- 1/8"	

Cellular Specialty Shades

SIMPLICITY MOTORIZED CELLULAR SHADES

Rechargeable Simplicity Motors

The Simplicity TDBU Motor program features a battery powered motor utilizing a rechargeable battery hidden inside the shade head rail. If shades are less than 36" in width, an external snap-on battery pack is necessary.

(See picture to right)

Applications

- TDBU Rectangular

EZ Level

Learn about the EZ Level feature on page 57.

Rechargeable Simplicity Motorization Surcharges

The Rechargeable Simplicity Motorized Lift System surcharge includes a rechargeable battery. Remotes are needed to operate the shades. Refer to pricing pages.

Ordering Information for Top Down-Bottom Up Motorized Cellular Shades

Simplicity Motor Option

- Specify IB or OB mount and rail color.
- 14 Channel TDBU Remote is required.
- Specify one or more battery chargers.

Please Note:

- Shades that are 24"-36" in width will have an external battery.
- Shades with an external battery and OB mounted will need spacer blocks.
- Simplicity Rechargeable Motorized Cellular Shades are programmed at the factory with the "up and down" limits.
- **REMEMBER: Order at least one charger if ordering rechargeable motors.**

Top Down-Bottom Up Simplicity Motor Hand Held 14 Channel Remote

The TDBU remote has 14-channels. Each channel has a setting to operate the middle rail and a setting to operate the bottom rail. The TDBU remote is required for TDBU motors. The **14 Channel TDBU remote** can operate up to fourteen shades individually or 14 groups. Simplicity Rechargeable Motorized Cellular Shades are programmed at the factory with the "up and down" limits. The shades are **UNLINKED** from the remote so they are not able to operate during shipping. Each shade should be installed **after** linking it to the remote.



Simplicity TDBU remotes and holders are white in color. The remote comes with a holder which can be mounted to a wall for easy storage. The range of the remote is approximately 80 feet.

Simplicity Rechargeable Battery

The rechargeable battery is concealed in the head rail of the shade. A charger is required for the rechargeable battery. The rechargeable battery comes fully charged from the factory.

Rechargeable Battery Pack is concealed in the head rail. Minimum width of 36" is required otherwise battery wand must be mounted externally.



Charging Port on Back of Head rail.



Snap-On external battery for shades under 36" in width. Spacer block also shown, required for outside mount.

Battery Charger

8.4 Volt charger requires a standard power outlet to recharge the battery wand. Must specify charger when ordering a Simplicity Rechargeable Wand Shade. The charger plugs into the charger port. The charger is black and comes with a 156" wire. The dimensions are 1" wide x 2½" length x 1¾" deep.



Solar Panel Recharge Option

Plugs in to any Simplicity Rechargeable Remote control shade (does not work with PowerTouch). See page 87.



Dimensions of panel 18½" x 1½"

MOTORIZED TOP DOWN-BOTTOM UP PRICING EXAMPLE:

Linen Weave	
Light Filtering 42" x 60" Shade:	\$386.00
Simplicity Rechargeable TDBU Surcharge:	\$535.00
Charger for Rechargeable:	\$27.00
TDBU Remote Control:	\$65.00
Total List Price:	\$1013.00

Cellular Shade Motorization Option SIMPLICITY SMART CONTROLLER

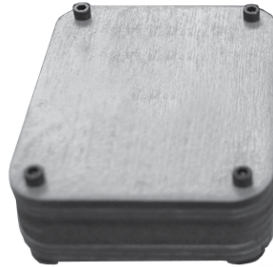

Simplicity Smart Controller Dimensions

- Width of controller: 2³/₈"
- Length of controller: 2¹⁵/₁₆"
- Height of controller: 1¹/₈"

Simplicity Smart Controller

- Works with Apple and Android devices
- FREE Downloadable Application
- Compatible with previously installed Simplicity Remote Control Shades
- Powered by NEO Smart Blinds App

Simplicity Smart Controller

The Simplicity Smart Controller is a small device that you install in your home that allows you to set automatic opening and closing times for all Simplicity motorized shades as well as the ability to control your motorized shades from a phone, tablet or PC from anywhere in world.

The Simplicity Smart Controller will work with any Comfortex remote motorized shade with Simplicity remote control motors purchased after 2012.

The Simplicity Smart Controller plugs into a standard electrical outlet and connects to WiFi and sends signals to your shades using the same radio frequencies as a normal remote control.

How Does The NEO Smart Blinds App Work?

The app uses WiFi or cellular data to send commands over the internet to the Simplicity Smart Controller.

Do I Need Any Other Equipment?

Yes, The location where your shades are installed must have WiFi in order for the Simplicity Smart Controller to work. Additionally, you must have a smartphone or tablet running Android or iOS (eg. iPhone, iPad, Samsung Galaxy S7) and have the NEO Smart Blinds app. installed.

Why Would I Want A Simplicity Smart Controller?

There are two main ways the Simplicity Smart Controller adds additional value to your motorized shades. First, once all of your shades have been added, you can use your smartphone as a single remote for all of your shades that will work anywhere you are regardless of distance from the shade. Secondly, the device allows you to set schedules so your motorized shades automatically open and close without needing to do anything on a day to day basis.

Do I Need To Buy More Than 1 Controller?

The normal use for the Simplicity Smart Controller is to plug it in out of the way and forget it. Since it has roughly the same range as a remote you will want enough devices to allow all shades to be operated without moving the controller. So depending on the layout of the home and location of the shade, you might want multiple devices to have convenient full home coverage.

How Far Is The Range Of A Controller?

You should see a range of approximately 150 ft. However this number might be less depending on the layout of your home. In general we recommend one per a floor of a normal sized home.

Can I Control My Shades From Multiple Devices?

Yes! You can download the NEO Smart Blinds App. onto multiple devices, After installing the App. on a new device simply log in with the same email/password on each device and you will have access to control your shades.

Can It Be Used With Already Installed Shades?

Yes! Simply follow the directions in the NEO Smart Blinds app. to add a shade. At the pairing step you can put the shade in pairing mode using the primary remote control for it (or by accessing the button on the shades motor). Adding the shade to the NEO Smart Blinds App. will not affect the normal remote operation.

How Much Does The NEO Smart Blinds App Cost?

The app is a free download, However you must have at least one Simplicity Smart Controller (\$330) to serve as a bridge between the app and your shades.

Cellular Shade Head Rail Options

POWERTOUCH RECHARGEABLE MOTORIZED CELLULAR SHADES

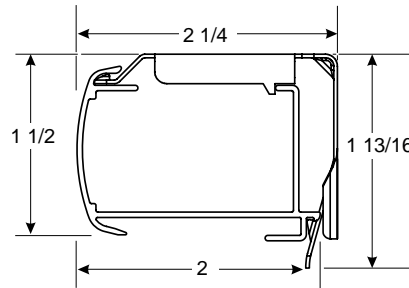
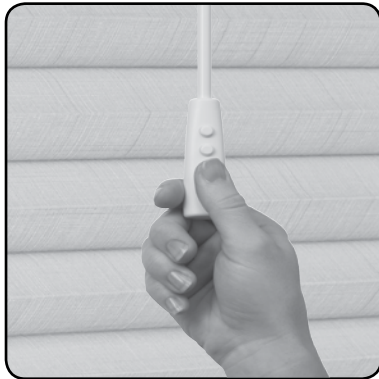

Simplicity Motorized Rail Dimensions

- Depth of rail: 2"
- Depth of rail and bracket: 2 1/4"
- Height of rail: 1 1/2"
- Height of bracket: 1 13/16"

Hardware Features	
Hardware colors for all Cellular and Pleated fabrics	Color coordinated head, bottom rails and end caps
Standard Hardware for all Custom Graphics	White head and bottom rails and end caps
Simplicity Remote	Upper and lower limit stops pre-programmed, Intermediate stop "favorites" position can be set on site

Upgrades	
Fabric Wrapped Upgrade	Fabric used is same fabric as the shade. Back of rail is white to outside. End caps on fabric wrapped head, middle and bottom rails are color coordinated
Designer Metallic Upgrade	<ul style="list-style-type: none"> • Smooth faced Oil Rubbed Bronze head, bottom rails and end caps • Smooth faced Brushed Nickel head, bottom rails and end caps

Mounting Dimensions	Simplicity Motorized Hardware System
Minimum Shallow Mount	1/2"
Minimum Flush Inside Mount	2 1/4"
Minimum Outside Mount	7/8"
Minimum Side Mount	1 1/4"
Minimum Flush Side Mount	2 1/4"
Recommended Side Mounting Method	<ul style="list-style-type: none"> • See page 56 for recommended mounting method for side mount shades • Width limit for side mount brackets is 48"

Finished Dimensions	
Inside Mount	
	<ul style="list-style-type: none"> • Fabric will measure ordered width less: 3/8" • Head rail* will measure ordered width less: 3/16"
Outside Mount	
	<ul style="list-style-type: none"> • Fabric will measure ordered width • Head rail* will measure ordered width plus: 3/16"
Side Mount	
	<ul style="list-style-type: none"> • Fabric will measure ordered width less: 7/8" • Head rail* will measure ordered width less: 1 1/16"
Exact (End Cap to End Cap) Mount	
	<ul style="list-style-type: none"> • Fabric will measure ordered width less: 3/16" • Head rail* will measure ordered width

* Head rail measurements include endcaps. Width and length measurements may vary +/- 1/8"

Cellular Shade Head Rail Options

POWERTOUCH RECHARGEABLE MOTORIZED CELLULAR SHADES

PowerTouch™ Rechargeable Shades

Cellular Shades can be fabricated with the PowerTouch Rechargeable Push Button Control option. The PowerTouch Rechargeable option is an easy, cord free motorized operation for the budget savvy homeowner. PowerTouch Rechargeable uses Simplicity motors and components.

PowerTouch Rechargeable Shades Operation

Press the up or down button on the pendant to raise or lower the shading to your desired position. When the shading is fully lowered to the factory programmed lower limit.

No programming is required with PowerTouch™, all programming is set at the factory. Upper and lower limits easily can be adjusted in the field if desired. Please refer to the installation instructions at comfortex.com/comfortex-dealers. A "favorites" or intermediate stop position can be set once installed.

PowerTouch Rechargeable Surcharges

See page 9.

PowerTouch Appearance

- The PowerTouch wand and pendant is attached to the head rail when installed.
- The wand and pendant hangs down the front of the shades from the head rail. The wand does not touch the fabric.
- Pendant is 2½" long.
- The pendant does not need to be mounted to the wall to operate the shade.



PowerTouch Rechargeable Color Options

- Shades with Black or Oil Rubbed Bronze hardware will be built with black wand and pendants standard. All other colors will use white wand and pendants.



White



Black Shown with Plug-In Charger

PowerTouch Wand and Pendant Location

The standard location for the wand and pendant is on the right. Please specify location when ordering.

PowerTouch Rechargeable Wand Length

- The standard length of the wand will measure the indicated below unless otherwise specified.

Shading Length	Standard Wand Length
Up to 30"	1' (12")
>30" to 52"	2' (24")
>52" to 78"	3' (36")
>78" to 100"	4' (48")
>100" to 120"	5' (60")

Mounting Requirements for PowerTouch Rechargeable Shades

- No special installation hardware or wiring requirements are needed.

Battery Charger

8.4 Volt charger requires a standard power outlet to recharge the battery wand. Must specify charger when ordering a Simplicity Rechargeable Wand Shade. The charger plugs into the charger port. The charger is black and comes with a 156" wire. The dimensions are 1" wide x 2½" length x 1¾" deep.



PowerTouch Rechargeable Shades Warranty

Please see page 135 for complete warranty information.

Cellular Shade Head Rail Options

OVATION CELLULAR SLIDER | Prelude Hardware Page 109

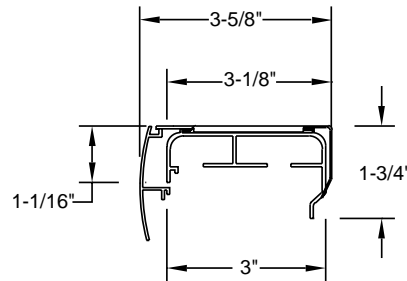

Ovation Hardware Rail Dimensions

- Depth of rail: 3"
- Depth of rail and bracket: 3 1/8"
- Depth of rail, bracket & valance: 3 5/8"
- Height: 1 3/4"

Hardware

Hardware Features	
Standard Hardware Color	Aspen White #785
Optional Hardware Colors	Ivory, beige, tan and gray rails are available as an option. Visit comfortex.com to view color options <ul style="list-style-type: none"> • Silverado #276 • Honey Bisque #882 • Camel #082 • Gardenia White #862

Mounting Dimensions	Ovation Hardware System
Minimum Inside Mount	3/4"
Minimum Flush Mount	3 5/8"
Minimum Outside Mount	5/8"

Finished Dimensions

Inside Flush Mount

Track Width:	
Right or Left Stack	3/16" less than ordered width
Split Stack	3/16" less than ordered width
Center Stack	3/16" less than ordered width
Finished Slider Length	1/2" less than ordered length
Valance	3/16" less than ordered width

Outside Mount

Track Width	Ordered width
Finished Slider Length	Ordered length - No reductions will be made
Valance	Ordered width plus 1 1/4"
Valance Returns	Will measure 3 1/8" (standard)

Cellular Shade

OVATION CELLULAR SLIDER | Prelude Hardware Page 109

Applications

- Standard Rectangular
- Opens and closes from side to side
- Four stacking options - see below.
- Dual Panel option with a center opening design with two fabrics, one on each side, each spanning the width of the window.

Ovation Stacking Options

Specify stacking configuration when ordering.

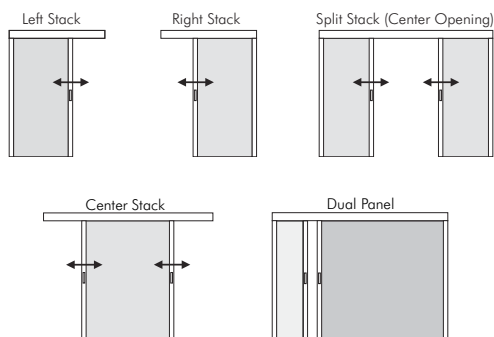

Left: Fabric stacks to the left side of the slider.

Right: Fabric stacks to the right side of the slider.

Center Stack: Center Stack Sliders fabric panels can move fully to the left or the right.

Split Stack: Fabric is split in the center of the slider forming two equal panels which open to opposite ends of the slider. Both panels will be of equal width unless otherwise specified. Split stack is not available with Gradient shades.

* Split stack sliders are available in maximum widths from 240" to 336" (maximum width depends on the fabric selected). If the width exceeds the maximum width of the fabric, it will be fabricated as two separate sliders. The supplied valance will create the appearance of a single slider. Call Customer Service for assistance.

Dual Panel: A Dual Panel Stack Slider has a center opening design with a different fabric on each side, each of which can span the full width of the window. Both panels will be of equal width unless otherwise specified. Specify which fabric stacks to left and which fabric stacks to the right.

Ordering Information for Ovation Cellular Sliders

- Specify IB or OB mount.
- Specify stacking configuration.
 - On Dual Panel Shades, specify which fabric stacks to the left and right.
 - On Split Stack Shades, both panels will be of equal width unless specified.
- Specify valance width and return length.

Ovation Valance Specifications

- Every Ovation Slider is supplied with a painted aluminum valance to match your hardware color choice.
- The valance attaches to the head rail using a durable plastic clip system.



Ovation Valance Dimensions

All valance dimensions are measured on the flat, back side.

- Valance Height: 2³/₄"
- Standard Return Length (OB only): 3¹/₈"
- For each spacer block, 1/2" will be added to the length of the valance returns. For extension brackets, 2" will be added unless otherwise instructed.
- If the slider requires a non-flush inside mount, you must order a custom valance. Exact valance width and exact valance return length (minimum 1 1/2") must be specified in the Special Instructions section of the order form.
- Custom returns are available for IB non-flush and OB Cellular Sliders. Please specify return length upon ordering.

Things to Consider

- Since most Ovations are sold in large sizes, the shade will have a large fabric stack. On an outside mount, you may want to order the shade a few inches wider so that the fabric stack can be clear of the window. For more information on Ovation's stack height, see page 16 for information.
- Premiere Custom Design fabrics will be turned 90 degrees on Ovation Shades. The pattern orientation will be left to right since Ovation shades open side to side. Split stack is not available with Gradient shades.
- Symphony double honeycomb fabric may require additional care when opening or closing the shade. Double honeycomb fabric is generally stiffer than single honeycomb material and may offer minor resistance when opening and closing. If this is a concern, Comfortex recommends selecting a coordinating fabric from the Virtuoso or Baritone collections.

The Ultimate Blackout Cellular Shade Head Rail Options

INSULATING SLUMBERSHADES

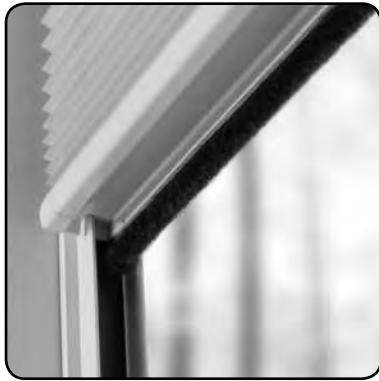

Standard Head Rail

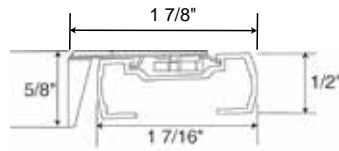

Deluxe Head Rail

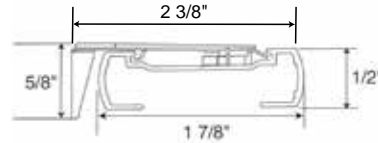

Cord Loop & Cordless Ultra Head Rail (Standard & Top Down-Bottom Up)

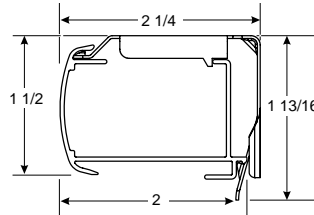

Standard Cord Lock Rail

- Depth of rail: 1 7/16"
- Depth of rail and bracket: 1 7/8"
- Height of rail: 1/2"
- Height of bracket: 5/8"

Deluxe Cord Lock Rail

- Depth of rail: 1 7/8"
- Depth of rail and bracket: 2 3/8"
- Height: 1/2"
- Height of bracket: 5/8"

Cord Loop & Cordless Ultra Rail

- Depth of rail: 2"
- Depth of rail and bracket: 2 1/4"
- Height of rail: 1 1/2"
- Height of bracket: 1 13/16"

Hardware Features		
Hardware colors for all Cellular fabrics	Color coordinated head, middle, bottom rails and end caps	
Blackout Sidetrack Colors Available	White, Tan and Bronze	
Upgrades		
Fabric Wrapped Upgrade	Fabric used is same fabric as the shade. Back of rail is white to outside.	
Designer Metallic Upgrade	• Oil Rubbed Bronze and Brushed Nickel head, middle, bottom rails and end caps.	
Mounting Dimensions (inside mount only)		
	Standard Head Rail	Deluxe Head Rail
Standard Cord Lock (Standard Retangular and Top Down-Bottom Up)		
Minimum Inside Mount	1 1/2"	1 1/2"
Minimum Flush Inside Mount	2"	2 3/8"
Cord Loop & Cordless Ultra (Standard Retangular and Top Down-Bottom Up)		
Minimum Inside Mount	1 5/8"	NA
Minimum Flush Inside Mount	2 1/4"	NA
Outside, shallow and side mounts are not available. The shade's light blocking ability is compromised by using any other mount than a fully flush mount application.		
Finished Dimensions		
Inside Mount		
	<ul style="list-style-type: none"> • Fabric will measure ordered width less: 7/8" • Head rail and bottom rail will measure ordered width less: 1 1/16" • Sidetrack length will measure ordered length less: 1/8" 	

The widest width of the window cannot exceed the narrowest width of the window by more than 1/4".

Precise width measurements are critical to proper performance of SlumberShade products. Make sure to measure to the nearest 1/16" and provide the **NARROWEST** width measurement along the length of the window. Be sure to measure the top, middle and bottom of the opening. It is very common for the width of a window to vary from top to bottom.

The Ultimate Blackout Cellular Shade Head Rail Options

INSULATING SLUMBERSHADE SHADES

Insulating SlumberShades Small Track Dimensions Used with all fabrics standard size head rail.

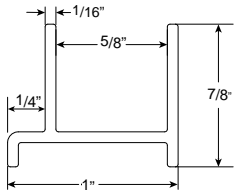

Small Track

- Width of track: 1"
- Height of track: 7/8"

Insulating SlumberShades Large Track Dimensions Used with all fabrics that utilize the deluxe sized head rail.

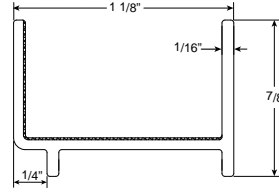

Large Track

- Width of track: 1 1/8"
- Height of track: 7/8"

Applications

- Standard Rectangular
- Top Down - Bottom Up
- Cordless and Cordless Top Down - Bottom Up
- Cord Loop and Top Down - Bottom Up

SlumberShades are for inside mount applications only.

Insulating SlumberShade Fabric

Light Filtering fabrics are available as SlumberShades, however the best light control is achieved by using a blackout cellular fabric.

Ordering Information for Insulating SlumberShades

SlumberShades are for inside mount applications only.

Precise width measurements are critical to proper performance of SlumberShade products. Make sure to measure to the nearest 1/16" and provide the **NARROWEST** width measurement along the length of the window. Be sure to measure the top, middle and bottom of the opening. It is very common for the width of a window to vary from top to bottom. The widest width of the window cannot exceed the narrowest width of the window by more than 1/4".

If you have questions about ordering SlumberShades, contact Comfortex Technical Services at 800-843-4151.

Accessories

- 6' Expandable Pole: \$37.00
- 12' Expandable Pole: \$46.00

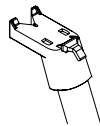

Specially designed pole end fits into the handle on the Cordless Ultra bottom rail and allows for easy operation.

Insulating SlumberShades Features

Use SlumberShades to provide the darkest sleeping environment by sealing out all the light

Energy Saving Blackout Sidetracks

Energy saving blackout sidetracks are made from a durable window grade PVC. The blackout sidetracks seal off the light gap between the blackout cellular shade and the window. The blackout sidetracks feature a black interior lining to absorb light and prevent it from entering the room.



SlumberShades are easy to install, and feature removable sidetracks that are attached to the window frame with magnets. The sidetracks can be removed for window cleaning. The UV stable, window grade PVC sidetracks are available in white, tan and bronze to match your existing trim.

Please Note: When properly installed, SlumberShades block 99% of all visible light. In certain installations with intense sunlight, a very small amount of light may reflect around the edges of the honeycomb fabric along each side of the shade. This is a normal attribute of the SlumberShade system.

Insulating SlumberShade End Caps

The specially designed notched bottom rail end caps fit over the blackout sidetracks and allow for smooth movement when raising and lowering the shade.

Head and Bottom Rail Seals

To ensure a perfectly dark sleeping environment, additional fuzzy seals are supplied to be placed along the shade's bottom rail and between the head rail and the window frame if needed. These barriers provide a complete light stop all the way around the window to keep all exterior light out. Also, these additional seals provide a very effective barrier against heat loss along your windows.

Magnets and fuzzy bar are standard on Cordless and Cordless Top Down-Bottom Up Shades to ensure closure between the bottom rail and window sill.

Energy Efficiency

Independent testing has shown SlumberShades provide an R-value greater than 7.0* when installed over a double paned vinyl window. The testing also indicates that the R-value of a SlumberShade is 2.5 to 3 times higher than that of the same shade without sidetracks. The insulating cellular fabric, sidetracks, and fuzzy seal all ensure that the SlumberShades provides superior energy efficiency.

* Independent testing provided by Consortium for Advanced Residential Buildings (CARB), a U.S. Department of Energy Building America research team. Learn more at comfortex.com/comfortex-dealers.

EZ Level

Learn about the EZ Level feature on page 119.

Cellular Specialty Shades

STARBURST ARCHES | Prelude Hardware Page 111

Stationary Starburst

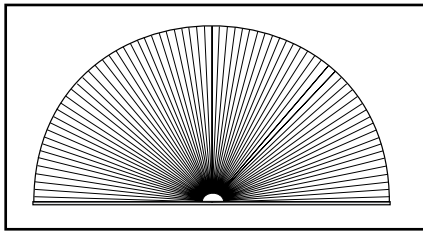

Figure A

Movable Starburst

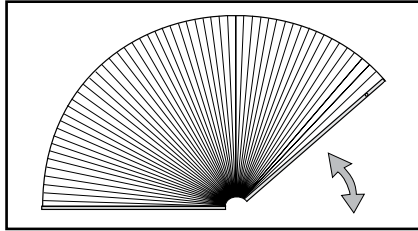

Figure B

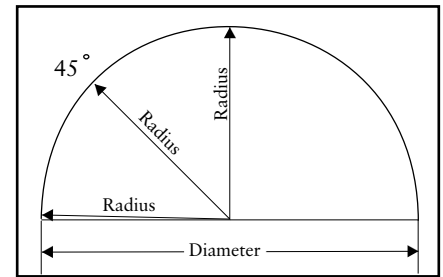

Figure C

Hardware Features See Page 53 for Rail Dimensions		
Hardware colors	Color coordinated rails	
Upgrades		
Fabric Wrapped Upgrade	Fabric used is same fabric as the shade. Back of rail is white to outside. Color coordinated end caps. Please note: On Stationary Starburst Arches the fabric wrap will be spliced in the center of the base rail.	
Designer Metallic Upgrade	<ul style="list-style-type: none"> • Oil Rubbed Bronze rails with bronze colored end caps. • Brushed Nickel rails and end caps. 	
Mounting Dimensions		
Minimum Shallow Mount	3/4"	3/4"
Minimum Flush Inside Mount	2"	2 3/8"
Recommended Side Mounting Method	<ul style="list-style-type: none"> • See page 54 figure B for recommended mounting method for side mount shades • Width limit for side mount brackets is 48" 	
Finished Dimensions		
Inside and Side Mount		
<ul style="list-style-type: none"> • Fabric will measure ordered width less: 3/8" • Head rail* will measure ordered width less: 3/16" 	<ul style="list-style-type: none"> * Head rail measurements include endcaps. Width and length measurements may vary +/- 1/8" 	

Applications

- Stationary Fan Style Arch
 - Movable Fan Style Arch
- Movable Starburst Arch shades are for inside and shallow mount applications only.

Stationary Starburst Features (Figure A)

- **All non-perfect Stationary Starburst arches require a template made from brown craft paper.** Comfortex offers template kits. Please contact Customer Service to order. Stock number: 751000, See page 131
- A perfect arch is twice as wide as it is high.
- Stationary Starburst shades which are not perfect half circles must have a height that equals half the width +/- 5".
- Price according to the largest radius measurement. If the height is greater than the width, take height X 2 and use that number to determine pricing.
- When ordering arches as perfect half-circles make sure the radius of the arch remains constant to ensure a proper fit. (See Figure C)

Movable Starburst Features (Figure B)

- Starburst Movable archtop shades are cut to perfect half circles only and do not require a template. The height must be exactly 1/2 the diameter.
- A perfect arch is twice as wide as it is high.
- When ordering arches as perfect half circles make sure the radius of the arch remains constant to ensure a proper fit. (See Figure C)
- The hinge gap (gap between the two rails) is not centered in the window. The moving rail is always smaller than the stationary rail to provide proper movement within the window.

Accessories

- 6' Expandable Pole: \$37.00
- 12' Expandable Pole: \$46.00

Specially designed pole end fits into the handle on movable Starburst Shades for easy operation.



Cellular Specialty Shades

SUNSET ARCHES | Prelude Hardware Page 112

Hardware

Movable Sunset

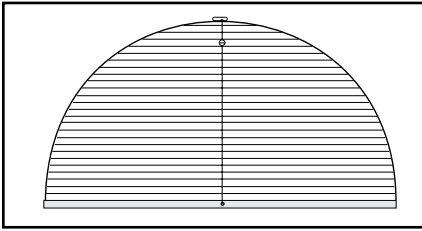

Figure A

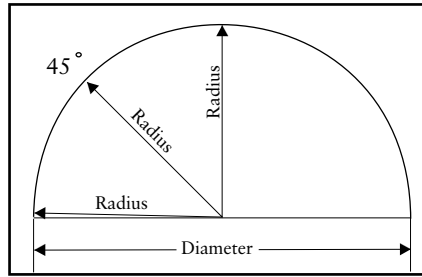

Figure B

Two-String Hanging Method

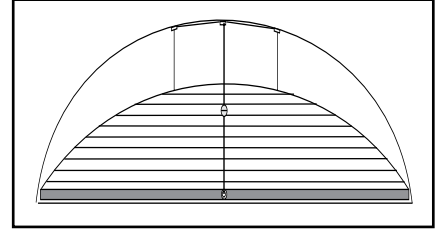

Figure C

Hardware Features | See Page 53 for Rail Dimensions

Hardware colors for all Cellular fabrics	Color coordinated rails with white cord and silver tassel
--	---

Upgrades

Fabric Wrapped Upgrade	Fabric used is same fabric as the shade. Back of rail is white to outside. Color coordinated end caps.
Designer Metallic Upgrade	<ul style="list-style-type: none"> • Oil Rubbed Bronze rails with bronze end caps, white cord and silver tassel. • Brushed Nickel rails and end caps with silver tassel and white cord.

Mounting Dimensions

	Standard Cord Lock Rail	Deluxe Cord Lock Rail
Minimum Shallow Mount	3/4"	3/4"
Minimum Flush Inside Mount	2"	2 3/8"
Minimum Outside Mount	3/4"	3/4"
Minimum Side Mount	1 1/8"	1 3/8"
Minimum Flush Side Mount	1 5/8"	1 7/8"

Recommended Side Mounting Method

- See page 62 figure B for recommended mounting method for side mount shades
- Width limit for side mount brackets is 48"

Finished Dimensions

Inside and Side Mount

- Fabric will measure ordered width less: 3/8"
- Head rail* will measure ordered width less: 3/16"

Outside Mount

- Fabric will measure ordered width
- Head rail* will measure ordered width plus: 3/16"

Exact (End Cap to End Cap) Mount

- Fabric will measure ordered width less: 3/16"
- Head rail* will measure ordered width

* Head rail measurements include endcaps.
Width and length measurements may vary +/- 1/8"

Applications

- Movable Arch

Ordering Information for Sunset Shades

- Specify IB or OB mount and rail color.
- Include a template if the shade is wider than 58".

Accessories

- 6' Expandable Pole: \$37.00
- 12' Expandable Pole: \$46.00



Specially designed pole end fits into the ball on Sunset Shades for easy operation.

Cellular Specialty Shades

SUNSET ARCHES | Prelude Hardware Page 112

Sunset Features and Ordering Notes (Figure A)

- Sunset shades have horizontal pleats that stack at the bottom, on a stationary sill rail. Sunset shades are operated by a continuous cord that runs through a top mount guide block and back down through the stationary rail. A moving metal ball attached to the cord is used to raise and lower the shade. (See Figure E).
- **All Sunset arches which are not perfect half circles require a template if shade is wider than 58".** A perfect arch is twice as wide as it is high. See page 131 for template instructions.
- **All templates should be made from brown craft paper.** Comfortex offers template kits. Please contact Customer Service to order. Stock number: 751000
- Sunset shades which are not perfect half circles must have a height which is equal to or greater than 25% of the width.
- When ordering Sunset shades that are perfect half circles, make sure the radius of the arch remains constant to ensure a proper fit. (See Figure B) on page 74.
- **Size Limitations:** Though our maximum width is 84" and our maximum length is 72", there are limitations on some larger sizes due to excessive weight. If the Sunset width exceeds 66", the maximum length is 60". If the Sunset width exceeds 72", the maximum length is 48".
- **Stringing Method:** Depending on the curvature of a particular arch, it may be necessary to use the two string method (See Figure C) to ensure proper fit and operation of your Sunset shade. Comfortex will determine the best stringing method after examination of the template.
- **For Symphony (All), Premiere 1/2" Fabrics, and Debut 1/2" single:** If Sunset shades exceed 65" in width or 50" in length, two pieces of mono filament cord are included to help stabilize the shade once installed.
- **For Debut 1/2" double, Debut 3/4" Fabrics and Linen Weave fabrics:** If Sunset shades exceed 45" in width or in length, two pieces of mono filament cord are included to help stabilize the shade once installed.
- **Arch Styles:** Sunset arches are available in a variety of styles including: palladium, eyebrow and bullet shaped arches. (See Figure D).

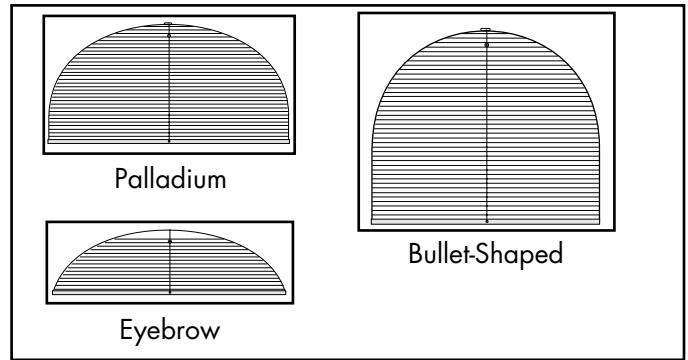

Figure D

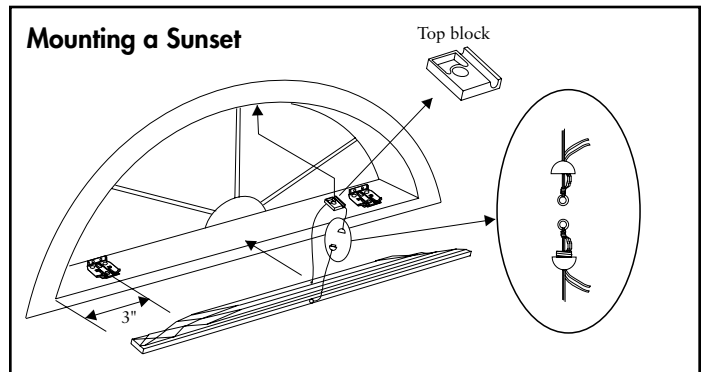

Figure E

Recommended Mounting Method for Side Mounting Shades

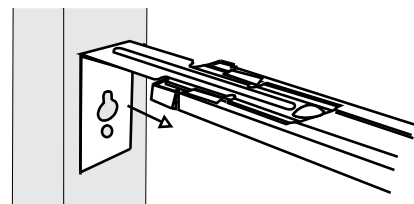

Figure F

Refer to the installation instructions on Comfortex.com/comfortex-dealers or the OnDemand Mobile Library for further details on side mounting shades.

Cellular Specialty Shades

QUARTER ROUNDS | *Prelude Hardware* Page 114

Hardware

Movable Quarter Round

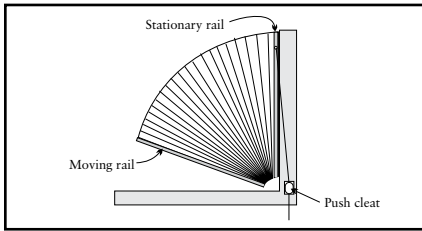

Figure A

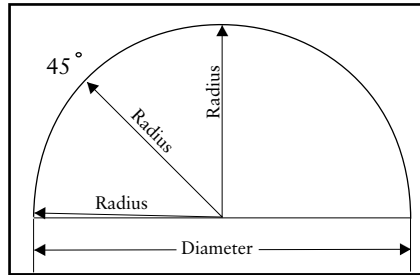

Figure B

Stationary Quarter Round

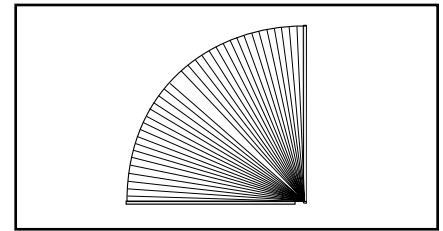

Figure C

Hardware Features | See Page 53 for Rail Dimensions

Hardware colors for all Cellular fabrics	Color coordinated rails with white cord and tassel
--	--

Upgrades

Fabric Wrapped Upgrade	Fabric used is same fabric as the shade. Back of rail is white to outside. Color coordinated end caps.
Designer Metallic Upgrade	<ul style="list-style-type: none"> • Oil Rubbed Bronze rails and endcaps, bronze colored tassel and white cord. • Brushed Nickel rails and end caps with coordinating tassel and white cord.

Mounting Dimensions	Standard Rail	Deluxe Rail
Minimum Shallow Mount	3/4"	3/4"
Minimum Flush Inside Mount	2"	2 3/8"
Minimum Outside Mount	3/4"	3/4"
Minimum Side Mount	1 1/8"	1 3/8"
Minimum Flush Side Mount	1 5/8"	1 7/8"
Recommended Side Mounting Method	• See page 75 figure F for recommended mounting method for side mount shades	

Finished Dimensions

Inside and Side Mount

- Fabric will measure ordered width less: 3/8"
- Head rail* will measure ordered width less: 3/16"

Outside Mount

- Fabric will measure ordered width
- Head rail* will measure ordered width plus: 3/16"

Exact (End Cap to End Cap) Mount

- Fabric will measure ordered width less: 3/16"
- Head rail* will measure ordered width

* Head rail measurements include endcaps.
Width and length measurements may vary +/- 1/8"

Applications

- Stationary Fan Style Quarter Round
- Movable Fan Style Quarter Round

Accessories

- 6' Expandable Pole: \$37.00
- 12' Expandable Pole: \$46.00



Specially designed pole end fits into the handle on movable Quarter Round Shades for easy operation.

Ordering Information for Quarter Rounds Shades

- Specify IB or OB mount and rail color.
- Include a template if the shade is a non-perfect quarter round.

Cellular Specialty Shades

QUARTER ROUNDS | *Prelude Hardware* Page 114

Quarter Rounds Features (Figure A)

- **All Quarter Round Shades which are not perfect quarter circles require a template.** Price according to the largest radius measurement.
- See page 131 for template instructions.
- **All templates should be made from brown craft paper.** Comfortex offers template kits. Please contact Customer Service to order. Stock number: 751000
- The horizontal (moving) rail of a Movable Quarter Round shade **must be smaller** than the vertical (stationary) rail to allow clearance for the moving rail. The shade will stack in the vertical position.
- When ordering arches as perfect quarter circles, make sure the radius of the arch remains constant to ensure a proper fit. (See Figure B)



Cellular Specialty Shades

TRAPEZOIDS AND OCTAGONS | Prelude Hardware Page 115

Movable Trapezoids

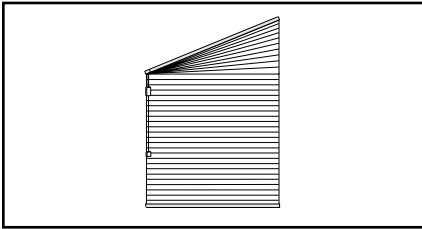

Movable Octagons

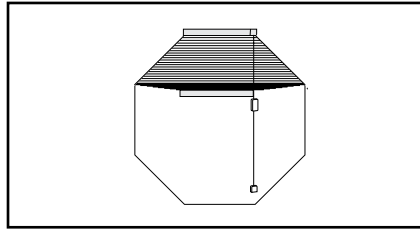

Hardware Features | See Page 53 for Rail Dimensions

Hardware colors for all Cellular fabrics	Color coordinated head and bottom rails with white cord and tassel
--	--

Upgrades

Fabric Wrapped Upgrade	Fabric used is same fabric as the shade. Back of rail is white to outside. Color coordinated end caps.
Designer Metallic Upgrade	<ul style="list-style-type: none"> • Oil Rubbed Bronze head and bottom rails with bronze colored tassel, end caps and white cord. • Brushed Nickel head and bottom rails and end caps with coordinating tassel and white cord.

Mounting Dimensions	Standard Cord Lock Rail	Deluxe Cord Lock Rail
Minimum Shallow Mount	3/4"	3/4"
Minimum Flush Inside Mount	2"	2 3/8"
Minimum Outside Mount	3/4"	3/4"
Minimum Side Mount	1 1/8"	1 3/8"
Minimum Flush Side Mount	1 5/8"	1 7/8"
Recommended Side Mounting Method	• See page 75 for recommended mounting method for side mount shades	

Finished Dimensions

Inside and Side Mount	
	<ul style="list-style-type: none"> • Fabric will measure ordered width less: 3/8" • Head rail* will measure ordered width less: 3/16"
Outside Mount	
	<ul style="list-style-type: none"> • Fabric will measure ordered width • Head rail* will measure ordered width plus: 3/16"
Exact (End Cap to End Cap) Mount	
	<ul style="list-style-type: none"> • Fabric will measure ordered width less: 3/16" • Head rail* will measure ordered width

* Head rail measurements include endcaps. Width and length measurements may vary +/- 1/8"

Applications

- Movable Trapezoids
- Movable Octagons

Ordering Information for Trapezoid Shades

- Specify IB or OB mount and rail color.
- Trapezoid orders must be faxed or emailed in with a diagram. Please provide measurements for all four sides when ordering. No template is required.

Ordering Information for Octagon Shades

- Specify IB or OB mount and rail color.
- Octagon Shades do not require a template. The width, length and one side are required measurements when ordering.

Cellular Specialty Shades

TRAPEZOIDS AND OCTAGONS | Prelude Hardware Page 115

Trapezoids (Figure A)

- Trapezoid orders must be faxed in with a diagram. Please provide measurements for all four sides when ordering. No template is required.
- The maximum slope of the top rail is 30 degrees from horizontal. Slope is the angle between slope and a horizontal line. The slope angle must be measured with a protractor.
- Sides of trapezoid must be parallel.
- Sill must be level for proper installation and operation of a trapezoid shade.
- Operating cord must be placed on the short side.
- See Figures B and C for trapezoid shade operation.

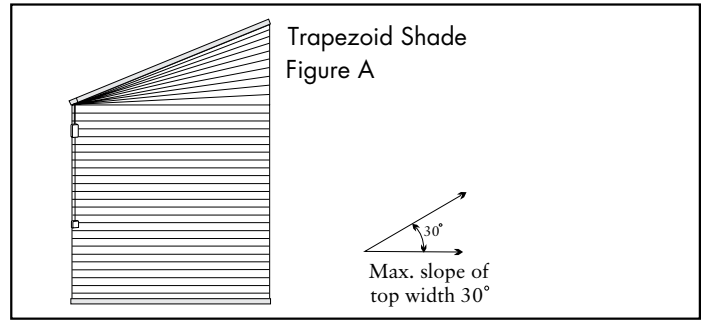

Octagons

- Octagon Shades do not require a template.
- The width, length and one side are required measurements when ordering.
- Octagon shades raise only to the point where the top angle begins. (See Figure D)
- See Figure F on page 75 for recommend mounting method for side mount shades.

Trapezoid Shade Operation

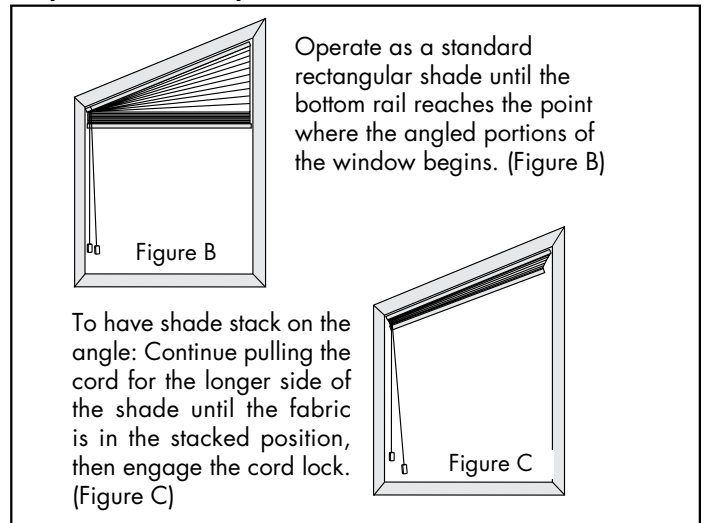

Octagon Operation

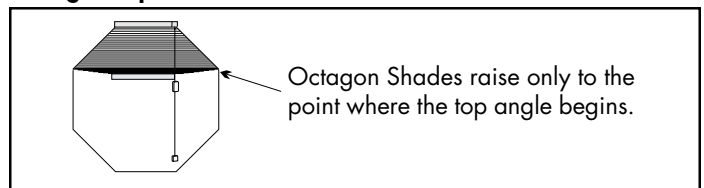

Cellular Specialty Shades

SOPRANO SKYLIGHTS AND GREENHOUSE SHADES

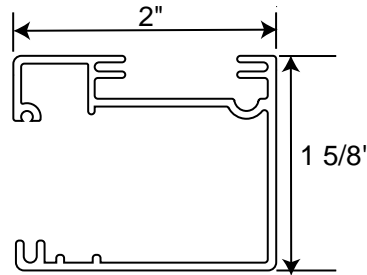

Soprano Rail Dimensions

- Depth of rail: 2"
- Height of rail: 1 5/8"

Hardware Features	
Hardware colors	<ul style="list-style-type: none"> • White head, bottom rail with white geartrack retainer. • Bronze head, bottom rail with bronze geartrack retainer.
Mounting Dimensions	Soprano Skylights and Greenhouse Shades
Minimum depth required for installation	1 1/2"
Minimum Flush Inside Mount (Rail Fully Recessed)	2 3/8"
Minimum Flush Inside Mount (Handle Fully Recessed)	3"
Deductions	
	Total deduction on the bottom moving rail is 3 1/4"
	Total deduction on the top rail is 1 1/2"
Finished Dimensions	
Inside Mount	
	<ul style="list-style-type: none"> • Fabric will measure ordered width less: 3/8" • Head rail* will measure ordered width less: 3/16"
* Head rail measurements include endcaps. Width and length measurements may vary +/- 1/8"	

Applications

- Soprano Skylights
 - Soprano Greenhouses
- Soprano Shades are for inside mount applications only.

Accessories

- Two Moving Rails: \$129.00
- 6' Expandable Pole: \$37.00
- 12' Expandable Pole: \$46.00



Specially designed pole end fits into the handle of Soprano shades for easy operation at any angle.

Ordering Information for Soprano Skylights and Greenhouse Shades

- Specify White or Bronze Rails.
- For Greenhouse Shades, supply measurements for: straight top section, curved section and vertical straight section when ordering.

Skylight Installation Angles

- For inside mount applications on straight (planar) runs.
- Minimum Installation angle of 5 degrees.
- Maximum installation angle of 85 degrees.
- Horizontal (0 degrees) and vertical (90 degrees) applications are not recommended.

Cellular Specialty Shades

SOPRANO SKYLIGHTS AND GREENHOUSE SHADES

Soprano Skylight Features (Figure A)

- Soprano Shades feature a polycarbonate track system. The hidden geartrack allows for smooth operation of the shade and controls light.
- The geartrack retainer is White or Bronze to match the moving bottom rail. **Please specify rail color when ordering.**

Soprano Greenhouse Shades Features (Figure B)

- See Figure C below for Greenhouse shade ordering information.
- Soprano Shades are for inside mount applications only.
- **All greenhouse orders require a completed and signed greenhouse shade order form.** Orders must be mailed or faxed to Comfortex for processing. Download a copy at www.comfortex.com/comfortex-dealers or from the OnDemand Library Mobile Library.
- Soprano Shades feature a polycarbonate track system. The hidden geartrack allows for smooth operation of the shade and controls light.
- The geartrack retainer is White or Bronze to match the moving bottom rail. **Please specify rail color when ordering.**

Soprano Skylights

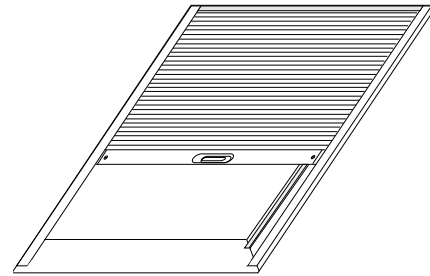

Figure A

Soprano Greenhouses

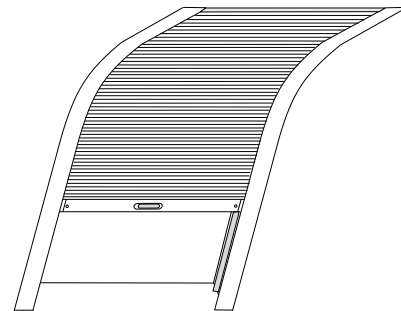
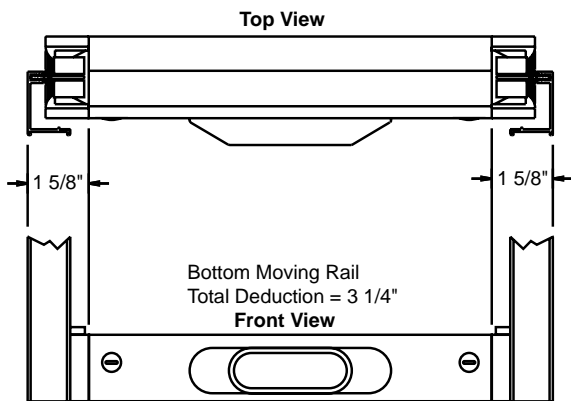
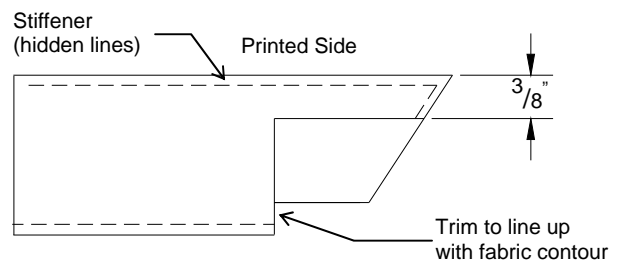

Figure B



Soprano Skylights and Greenhouses Moving Rail
Top and Front View

Soprano Fabric Notch



Additional trimming for bottom stiffener (and attached single layer of fabric).

Greenhouse Ordering Information Figure C

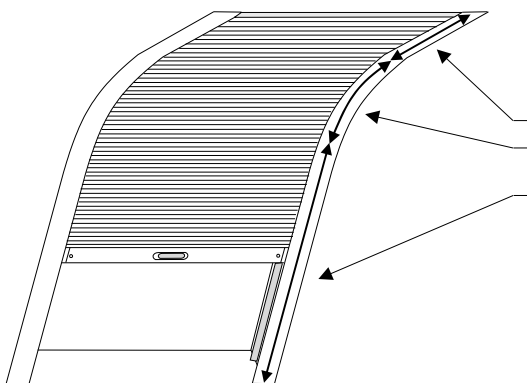

The side rails for greenhouse shades are notched at the curve in the factory. Please supply measurements for:
Straight top section,
Curved section and
Vertical straight section when ordering.

Cellular Specialty Shades BALCONY SHADING SYSTEM

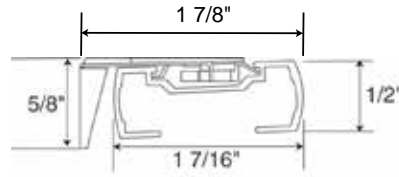

Balcony Rail Dimensions

- Depth of rail: 1 7/16"
- Depth of rail and bracket: 1 7/8"
- Height of rail: 1/2"

Hardware Features

Hardware colors for all fabrics	Color coordinated head and bottom rails with white cord in a white sidetrack.
---------------------------------	---

Upgrades

Fabric Wrapped Upgrade	Fabric wrapped head and bottom rails. Fabric used is same fabric as the shade. Back of rail is white to outside.
Designer Metallic Upgrade	<ul style="list-style-type: none"> • Designer Oil Rubbed Bronze head and bottom rails with white cord in a white sidetrack. • Designer Brushed Nickel head and bottom rails with white cord in a white sidetrack.

Mounting Dimensions - Inside Only	Balcony Shading System
Minimum required for installation	1 1/4"
Minimum Flush Inside Mount (Rail Fully Recessed)	2 1/4"
Minimum Flush Inside Mount (Handle Fully Recessed)	2 1 1/16"

The widest width of the window cannot exceed the narrowest width of the window by more than 3/8".

Finished Dimensions

Inside Mount

<ul style="list-style-type: none"> • Fabric will measure ordered width less: 3/8" • Head rail* will measure ordered width less: 3/16"

* Head rail measurements include endcaps. Width and length measurements may vary +/- 1/8"

Applications

- Horizontal, Angled and Vertical rectangular windows and skylights. Balcony Shading Systems are for inside mount applications only.

Accessories

- 6' Expandable Pole: \$37.00
- 12' Expandable Pole: \$46.00



Specially designed pole end fits into the handle of Balcony shades for easy operation at any angle.

Ordering Information for Balcony Shading System

- Specify rail color.
- Specify when ordering: Application angle: Angled, Horizontal or Vertical.

Cellular Specialty Shades BALCONY SHADING SYSTEM

Balcony Shading System Features

- Balcony Shades work in three orientations applications: Angled, Horizontal and Vertical.
Horizontal works on slope angles 0 to 15 degrees.
Angled works on slope angles 15 to 75 degrees.
Vertical works on slope angles 75 to 90 degrees.
- Balcony shades can be mounted on their side. (See Figure A). Use the vertical measurement as your width (max. 36") and the horizontal measurement as your length (max. 48").
- Polycarbonate track system provides superior insulation and light blocking. The enclosed sides provide full privacy.
- No exposed cords, eliminates risk of injury to children.

Balcony Vertical Applications

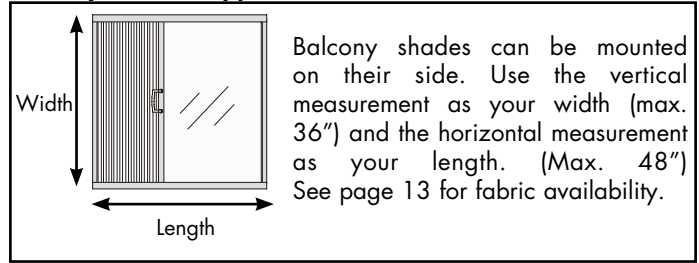

Balcony shades can be mounted on their side. Use the vertical measurement as your width (max. 36") and the horizontal measurement as your length. (Max. 48") See page 13 for fabric availability.

Figure A

Maximum Shade Area

Maximum shade areas (in square feet) varies with slope and fabric type.

	Horizontal	Angled	Vertical
Symphony (All)	24	24	18
Debut Light Filtering (All)	24	24	18
Virtuoso (All)	24	24	18



Cellular Specialty Shades

MEZZO MOTORIZED SKYLIGHT SHADES

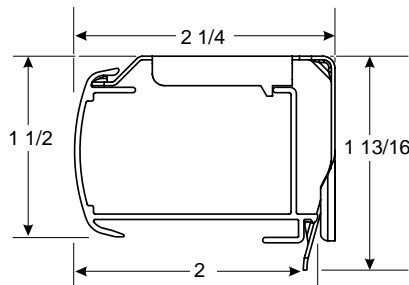

Simplicity Motorized Rail Dimensions

- Depth of rail: 2"
- Depth of rail and bracket: 2 1/4"
- Height of rail: 1 1/2"
- Height of bracket: 1 13/16"

Hardware Features

Hardware colors	White head, bottom and side rails
Simplicity Remotes	Upper and lower limit stops pre-programmed, Intermediate stop "favorites" position can be programmed on-site, 5 Channel or 6 Channel Timer option

Mounting Dimensions

Mounting Dimensions	Mezzo Motorized Skylight Shades
Minimum Flush Inside Mount	2 1/2"
	<ul style="list-style-type: none"> • Should not be more than 1/2" out of square to perform as intended • The widest width of the window cannot exceed the narrowest width of the window by more than 3/8". • The shade must be mounted with the fabric stack at the bottom or the lowest point of the window
	See page 85 for Solar Panel Mounting information.

Finished Dimensions

Inside Mount	
	<ul style="list-style-type: none"> • Fabric will measure ordered width less: 1 1/4" • Head rail* will measure ordered width less: 3/16"

* Head rail measurements include endcaps. Width and length measurements may vary +/- 1/8"

MOTORIZATION - HARDWARE UPGRADE SURCHARGES AND ACCESSORIES All standard discounts apply to motorized shades	ADD
Simplicity - Motor and Battery Wand	\$334
Simplicity 5 Channel Remote	\$40
Simplicity 6 Channel Remote with Timer	\$65
48" Extension Wire:	\$18
DC Power Supply	\$63
Simplicity Smart Controller (NEO)	\$330
7.4v Solar Panel & Mounting Brackets	\$75
DC Power Supply	\$63

Applications

- Horizontal, Angled and Vertical motorized skylight shades.
- Mezzo Motorized Skylight Shades are for inside mount applications only.

Ordering Information for Mezzo Motorized Skylight Shades

- Specify inside mount dimensions.
- Specify fabric color and style.
- Specify remote and other accessories if needed.

Cellular Specialty Shades

MEZZO MOTORIZED SKYLIGHT SHADES

Applications

- Horizontal, Angled and Vertical motorized skylight shades.
- Mezzo Motorized Skylight Shades are for inside mount applications only.

Mezzo Power Options

- Simplicity Rechargeable Motor

RECHARGEABLE SIMPLICITY MOTORS

The Simplicity Motor program features a battery powered motor utilizing a rechargeable battery hidden inside the shade head rail. Simplicity motors are compact and use a radio frequency remote to raise or lower the shades.

Simplicity Rechargeable Battery

The rechargeable battery is concealed in the head rail of the shade. A charger is required for the rechargeable battery. The rechargeable battery comes fully charged from the factory.



Charging Port on Back of Head rail.

Simplicity Hand Held Remotes

The **5 Channel (5C) remote** can operate up to five shades individually or 5 groups. Simplicity Rechargeable Motorized Cellular Shades are programmed at the factory with the "up and down" limits. The shades are **UNLINKED** from the remote so they are not able to operate during shipping. Each shade should be installed **after** linking it to the remote.

Simplicity 5C remotes and holders are white or black in color. The remote comes with a holder which can be mounted to a wall for easy storage. The range of the remote is approximately 80 feet.

A **6 Channel (6C) timer remote** is also available. See page 65 for more information

Simplicity remotes and holders are black in color. The remote comes with a holder which can be mounted to a wall for easy storage. The range of the remote is approximately 80 feet.

The Simplicity remote utilizes one 3V battery (CR2032). Batteries are included. Comfortex will warranty batteries for up to 3 months from date of purchase. Batteries are not covered by the warranty.



Solar Panel Recharge Option

Plugs in to any Simplicity Rechargeable Remote control shade (does not work with PowerTouch)

Provides constant trickle charge to 7.4v Li-Ion Rechargeable battery packs. Does not require direct sunlight, but performs best in regular direct sunlight applications. Will prolong the life of the charge of the 7.4v rechargeable battery packs, and in some applications will maintain charge indefinitely.

Life of charge is subject to application variables such as, size and weight of shade, frequency of use, amount of direct sunlight exposure, etc.



Dimensions of panel
18½" x 1½"

Solar Recharge Optimum Application

- Full direct sunlight (minimum 4-6 hours per day) to maintain full charge. Based on one operation cycle per day (one open, one close).
- Solar panel will charge batteries even without direct sunlight. Ambient light will charge the batteries but at a slower rate.
- Excessive duration of cloudy weather will impact the rate of charge.

Battery Charger

8.4 Volt charger requires a standard power outlet to recharge the battery wand. Must specify charger when ordering a Simplicity Rechargeable Wand Shade. The charger plugs into the charger port. The charger is black and comes with a 156" wire. The dimensions are 1" wide x 2½" length x 1¾" deep.



Cellular Specialty Shades

MEZZO MOTORIZED SKYLIGHT SHADES

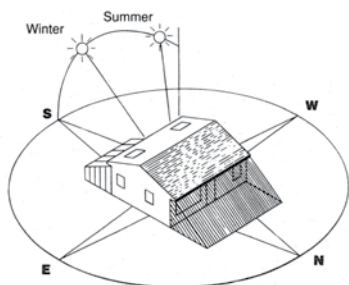

For Locations North of Washington, DC (39° Latitude)



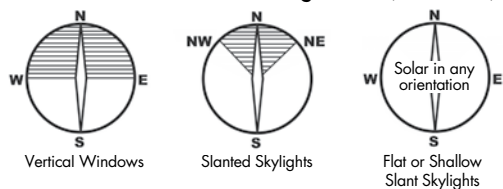

For Locations South of Washington, DC (39° Latitude)



- Assumptions:** 1) Window area free from shadows 9 AM to 3 PM.
2) Glazing is double pane, clear.

Excessive shading or tinted glass will impact the solar charging capability of the system.

-  Indicates orientations which may require periodic manual recharge with Plug In Charger.
-  Indicates orientations which are optimum for solar recharge (wireless systems).

Retrofit Existing Standard Simplicity Motorized Shades with Rechargeable Batteries

Cellular shades made with Standard Simplicity Motorization can be retrofitted with the Rechargeable Simplicity Motorization Battery Wand. The Rechargeable battery wand is 22" long, comes with 10 NiMH batteries, and is white in color. Battery wands are charged at the factory.



Battery Wand for Rechargeable Simplicity Retrofit

See page 64 for further details. Please contact customer service for more information.

Important Simplicity Motorized Shades Operating and Installation Information

- Simplicity Motorized Shades installed into windows with metal casings may have a reduced radio frequency range, or may not operate at all, depending on the application.
- Do not let the antenna on the motor touch any metal objects. This may interfere with signals from the remote control.



Cellular Specialty Shades
FRENCH DOOR DÉCOR



Standard Head Rail

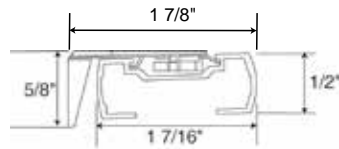

Deluxe Head Rail

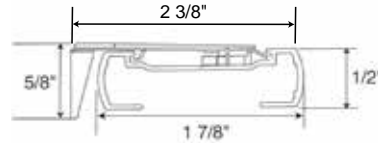

Standard Rail

- Depth of rail: 17/16"
- Depth of rail and bracket: 17/8"
- Height of rail: 1/2"
- Height of bracket: 5/8"

Deluxe Rail

- Depth of rail: 17/8"
- Depth of rail and bracket: 23/8"
- Height: 1/2"
- Height of bracket: 5/8"

Hardware Features

Hardware colors	Color coordinated head, middle, bottom rails and end caps
-----------------	---

Upgrades

Fabric Wrapped Upgrade	Fabric used is same fabric as the shade. Back of rail is white to outside. Color coordinated end caps
Designer Metallic Upgrade	<ul style="list-style-type: none"> • Oil Rubbed Bronze head, middle, bottom rails and end caps. • Brushed Nickel head, middle, bottom rails and end caps.

Mounting Dimensions	Standard Rail	Deluxe Rail
Minimum Shallow Mount	3/4"	3/4"
Minimum Flush Inside Mount	2"	2 1/2"
Minimum Flush Inside Mount (Handle Fully Recessed)	2 9/16"	3"
Minimum Outside Mount	3/4"	3/4"
Minimum Side Mount	1 1/8"	1 3/8"

The widest width of the window cannot exceed the narrowest width of the window by more than 3/8".

Recommended Side Mounting Method	<ul style="list-style-type: none"> • See page 75 for recommended mounting method for side mount shades • Width limit for side mount brackets is 48"
---	---

Finished Dimensions

Inside and Side Mount

	<ul style="list-style-type: none"> • Fabric will measure ordered width less: 3/8" • Head rail* will measure ordered width less: 3/16"
--	---

Outside Mount

	<ul style="list-style-type: none"> • Fabric will measure ordered width • Head rail* will measure ordered width plus: 3/16"
--	--

Exact (End Cap to End Cap) Mount

	<ul style="list-style-type: none"> • Fabric will measure ordered width less: 3/16" • Head rail* will measure ordered width
--	--

* Head rail measurements include endcaps. Width and length measurements may vary +/- 1/8"

Cellular Specialty Shades

FRENCH DOOR DÉCOR

Applications

- Stationary Door Décor
- Movable Door Décor
- Top Down - Bottom Up Door Décor
- Cover french doors, transoms, and side lights.

French Door Décor Hardware Features

- Features two non-moving rails which are mounted in the window or door. A tension control system enables the movable rail to be easily moved with the touch of a finger. The only visible cords are the ones that hold the movable middle rail in place.
- The widest width of the window cannot exceed the narrowest width of the window by more than $\frac{3}{8}$ ".

Stationary Non-Movable French Door Décor Shades

- Top and bottom rails are mounted to the window and are stationary.

Movable French Door Décor Shades

- Top and bottom rails are mounted to the window, one middle movable rail raises from the bottom.

Top Down - Bottom Up Option

- Top and bottom rails are mounted to the window, two movable rails allow the shade to lower from the top and raise from the bottom.
- The non-movable top and bottom rails are attached to the window or door.
- Ideal for entry ways with narrow windows next to doors and other narrow windows that are easily accessible.

Ordering Information for French Door Décor

- Specify IB or OB mount and rail color.
 - Specify stationary, movable or Top Down - Bottom Up.
- You may want to specify hold down brackets if mounting on a door.

Accessories

- 6' Expandable Pole: \$37.00
- 12' Expandable Pole: \$46.00

Specially designed pole end allows for easy operation of French Door Décor Shades.

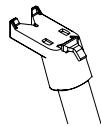

French Door Decor Cellular Shades Hardware

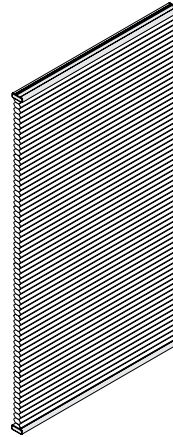

Stationary Non-Movable

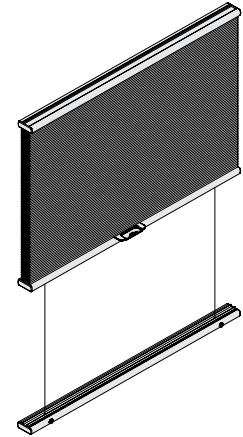

Shown open with movable rail option

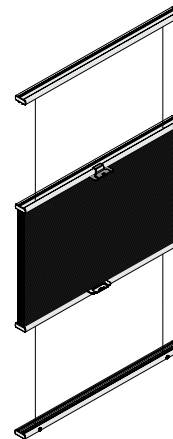

Shown open with Top Down - Bottom Up Option

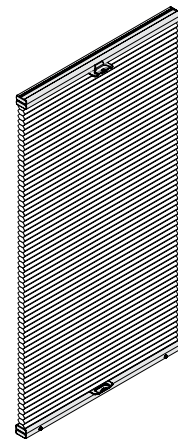

Shown closed with Top Down - Bottom Up Option

Cellular Specialty Shades

DAY-NIGHT SHADES



Standard Cord Lock Rail

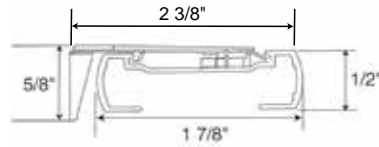
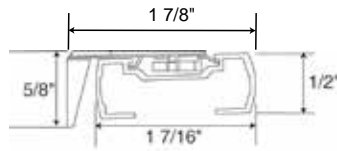

Standard Cord Lock Rail

- Depth of rail: 1 7/16"
- Depth of rail and bracket: 1 7/8"
- Height of rail: 1/2"
- Height of bracket: 5/8"

Deluxe Cord Lock Rail

- Depth of rail: 1 7/8"
- Depth of rail and bracket: 2 3/8"
- Height: 1/2"
- Height of bracket: 5/8"

Hardware Features	
Hardware colors for all Cellular and Pleated fabrics	Color coordinated head, middle and bottom rails with white cord and tassel. See additional details on page 90.
Upgrades	
Fabric Wrapped Upgrade	Fabric used is same fabric as the shade. Back of rail is white to outside. Color coordinated end caps.
Designer Metallic Upgrade	<ul style="list-style-type: none"> • Oil Rubbed Bronze head and bottom rails with bronze colored tassel, end caps and white cord. • Brushed Nickel head and bottom rails and end caps with coordinating tassel and white cord.
Mounting Dimensions	
Minimum Shallow Mount	Standard Rail: 3/4" Deluxe Rail: 3/4"
Minimum Flush Inside Mount	Standard Rail: 2" Deluxe Rail: 2 3/8"
Minimum Outside Mount	Standard Rail: 3/4" Deluxe Rail: 3/4"
Minimum Side Mount	Standard Rail: 1 1/8" Deluxe Rail: 1 3/8"
Recommended Side Mounting Method	<ul style="list-style-type: none"> • See page 75 for recommended mounting method for side mount shades • Width limit for side mount brackets is 48"
Finished Dimensions	
Inside and Side Mount	
	<ul style="list-style-type: none"> • Fabric will measure ordered width less: 3/8" • Head rail* will measure ordered width less: 3/16"
Outside Mount	
	<ul style="list-style-type: none"> • Fabric will measure ordered width • Head rail* will measure ordered width plus: 3/16"
Exact (End Cap to End Cap) Mount	
	<ul style="list-style-type: none"> • Fabric will measure ordered width less: 3/16" • Head rail* will measure ordered width
* Head rail measurements include endcaps. Width and length measurements may vary +/- 1/8"	

Applications

- Standard Rectangular with cellular fabrics only.

Fabrics

- Some fabrics (i.e. Symphony Blackout) can be used exclusively only as a bottom panel only.

Day - Night Shade Specifications

Refer to the appropriate fabric sections for proper pricing.

Cellular Specialty Shades

DAY-NIGHT SHADES

Rail Colors and Cord Colors

- **Color Coordinated Rail Shades:** The top rail and middle rail will coordinate with top fabric and bottom rail will coordinate with the bottom fabric. The cord and tassel will be white. Not available with Color Lux Shades.
- **Designer Metallic Hardware Shades:** All rails, end caps and tassels will be the selected metallic color. Cords will be white.
- **Fabric Wrapped Rail Shades:** The top rail and middle rail will coordinate with top fabric and bottom rail will coordinate with the bottom fabric. The cord and tassel will be white. End caps and cord lock will be color coordinated.

Ordering Information for Day - Night Shade

- Specify fabrics, top and bottom panels.
- Specify IB or OB mount and rail color.

TOP FABRIC

CELLULAR	Width		Length	
	Min	Max	Min	Max
Verona	12"	72"	18"	96"
Boutique	12"	72"	18"	96"
Debut 1/2" Double Cell Light Filtering	12"	72"	18"	96"
Debut 1/2" Single Cell Light Filtering	12"	72"	18"	96"
Debut 3/4" Single Cell Light Filtering	12"	72"	18"	96"
Linen Weave Light Filtering*	12"	72"	18"	96"
Linen Weave Room Darkening*	NA	NA	NA	NA
Premiere 1/2" Single Cell Blackout	NA	NA	NA	NA
Premiere 1/2" Single Cell Light Filtering	12"	72"	18"	96"
Premiere 3/4" Single Cell Blackout	NA	NA	NA	NA
Premiere 3/4" Single Cell Light Filtering	12"	72"	18"	96"
Symphony 3/8" Double Cell Blackout	NA	NA	NA	NA
Symphony 3/8" Double Cell Light Filtering	12"	72"	18"	96"

BOTTOM FABRIC

Width		Length	
Min	Max	Min	Max
12"	72"	18"	96"
12"	72"	18"	96"
12"	72"	18"	96"
12"	72"	18"	96"
12"	72"	18"	96"
12"	72"	18"	96"
12"	72"	18"	96"
12"	72"	18"	96"
12"	72"	18"	96"
12"	72"	18"	96"
12"	72"	18"	96"

* Day-Night Shades can only be built in conjunction with other 3/4" cellular fabrics. All Debut includes print patterns: Strie, Terazzo, Angel Hair, Strat, Florance, Blossom, Country Woven and Homespun.

Cellular Specialty Shades

CUSTOM GRAPHICS

Custom Graphics

With Custom Graphics, you can print anything on a Cellular Shade. From logos to personal photos, theme room graphics or advertising for your storefront, anything you envision can be featured on a Custom Graphics Cellular Shade.

Hardware | Mounting | Finished Dimensions

See Page 53

Available Fabrics

Custom Graphics are available with the following fabrics:

- Premiere 1/2" and 3/4" Light Filtering Fabrics
- Premiere 1/2" and 3/4" Blackout Fabrics

Custom Graphics can work for any window.

Advertising and Store Identification

Contact local businesses and explain how you can to turn their window space into advertising!



Decorative and Personal Photos

Customers can now convert their special photos into a highly personalized room!

Printing Information and Options

Custom Graphics will look different from fabric to fabric. The color vibrancy on cellular shades will be muted due to the density of the fabrics and the printing process.

To view the color differences on Cellular Shades, visit the Custom Graphic section of the Comfortex Dealers website.

Single Sided Printing:

Cellular Custom Graphics are available as single-sided only. Double-sided graphics are not available.

You can choose to have Side A face the room side or the street side.



Side A
Shows Printed Image



Side B
White Fabric

Ordering Information for Custom Graphics Cellular Shades

Step 1. Fill out the Custom Graphics Cellular Shades

Order Form. This form includes your fabric and hardware selections. Fax the completed order form to (800) 336-4580 to place your order.

Custom Graphic orders can only be placed by faxing this form.

Step 2. Receive your Comfortex Work Order Confirmation

number. Be sure to reference this number when submitting you artwork in Step 3.

Step 3. Send your graphic files via email to:

CustomGraphics@Comfortex.com

Or ship a CD containing your graphics to:

Custom Graphics
Comfortex Window Fashions
21 Elm Street
Maplewood, NY 12189

Graphic File Specifications

Preferred Formats:

- Adobe Illustrator
- EPS

Other Accepted Formats:

- TIFF
- JPEG
- PSD

- All typography should be converted to paths when submitting an Illustrator or EPS file.
- TIFF and JPEG files should be submitted at the largest size possible, 300 DPI is preferred. We will size your graphics according to your shade size and specifications.
- Contact Comfortex Customer Care at 800-843-4151 with all questions regarding Custom Graphic Orders.
- Comfortex will not print any copyrighted custom graphics without appropriate permission.

Step 4. The Custom Graphic Team will email a PDF proof of your shade order for you to approve. Once the artwork is approved, it will take two weeks for your order to be printed, assembled, and shipped.

**Prelude Cellular
STANDARD CORD LOCK SHADES**

Prelude Hardware

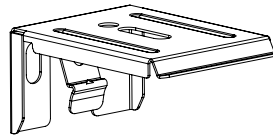

Standard Bracket

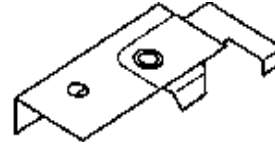

Swivel Bracket



End Mount Bracket

Hardware Features			
Standard Hardware colors for Comfortex Prelude	Color coordinated head, middle and bottom rails with color coordinated cord and tassel.		
Upgrades			
Fabric Wrapped Upgrade	Not Available on Cord Lock Shades		
Designer Metallic Upgrade	Not Available on Cord Lock Shades		
Mounting Dimensions			
Minimum Depth Inside Mount	1 ¼"	½"	NA
Minimum Flush Inside Mount	2 ¼"	2"	2"
Minimum Outside Mount	1"	1"	1"
Maximum End Mount Shade width 36"			
Finished Dimensions			
Inside Mount			
	<ul style="list-style-type: none"> Fabric will measure ordered width less: ⅜" Head rail* will measure ordered width less: ⅜" Length will measure ordered length 		
Outside Mount			
	<ul style="list-style-type: none"> Fabric will measure ordered width Head rail* will measure ordered width plus: ⅜" Length will measure ordered length 		
* Head rail measurements include endcaps. Width and length measurements may vary +/- ⅛"			

NOTE: An additional ¼" width deduction is taken on shades ordered Inside Mount with hold down brackets.

Prelude Cellular

STANDARD CORD LOCK SHADES

Applications

- Standard Rectangular
- Top Down - Bottom Up
- Two-On-One Head Rail
- Three-On-One Head Rail

Things to Consider

- If child or pet safety is a concern, consider Cordless Ultra.
- Larger shades can be difficult to operate. Consider Cord Loop hardware.
- If privacy is an issue, consider Top Down-Bottom Up options.

Ordering Information for Standard Cord Lock Shades

Standard Rectangular

- Specify IB or OB mount, and left or right lift cord.

Top Down - Bottom Up

- Specify IB or OB mount.
Top Down - Bottom Up Shades are made with two operating cord locks, one on the left and one on the right side of shade. The right cord lowers the middle rail and left cord raises the bottom.
- On Top Down - Bottom Up Shades, an extra two-cell fabric gasket attached to the top head rail and acts as a seal to eliminate light leakage between the head rail and middle rail when the shade is closed.



Two-On-One Head Rail

Two-On-One Head Rail Shades operate as two separate shades on one head rail.

- Specify IB or OB mount.
- Specify panel sizes.
- Maximum width in a single panel depends on fabric type. See page 3 for maximum single panel width.
- ¼" to maximum ½" Space between panels.

Prelude Cellular CORD LOOP HARDWARE SYSTEM

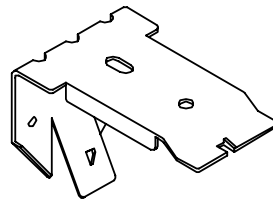

Standard Bracket

Prelude Hardware

Hardware Features	
Standard Hardware colors for Comfortex Prelude	Color coordinated head, bottom rails and end caps with a white cord and tensioner
Upgrades	
Fabric Wrapped Upgrade	Fabric used is same fabric as the shade. Back of rail is white to outside. Color coordinated end caps for rails.
Designer Metallic Upgrade	<ul style="list-style-type: none"> • Smooth faced Oil Rubbed Bronze head, bottom rails and end caps with bronze tensioner and bronze cord. • Smooth faced Brushed Nickel head, bottom rails and end caps with coordinating tensioner and cord.

Mounting Dimensions	Cord Loop Hardware System
Minimum Inside Mount	3/4"
Minimum Flush Inside Mount	2 1/8"
Minimum Outside Mount Flat Vertical Surface	1 1/2"
Maximum End Mount Shade width 48"	

Finished Dimensions -Standard Rectangular and Top Down-Bottom Up	
Inside Mount	
	<ul style="list-style-type: none"> • Fabric will measure ordered width less: 3/8" • Head rail* will measure ordered width less: 1/4" • Length will measure ordered length
Inside Mount with Hold Down Brackets	
	<ul style="list-style-type: none"> • Fabric will measure ordered width less: 5/8" • Head rail* will measure ordered width less: 1/2" • Bottom rail* will measure ordered width less: 1/2" • Length will measure ordered length
Outside Mount	
	<ul style="list-style-type: none"> • Fabric will measure ordered width less: 1/8" • Head rail* will measure ordered width • Length will measure ordered length
* Head rail measurements include endcaps. Width and length measurements may vary +/- 1/8"	

NOTE: An additional 1/4" width deduction is taken on shades ordered Inside Mount with hold down brackets.

Prelude Cellular CORD LOOP HARDWARE SYSTEM

Finished Dimensions -Two-On-One	
Inside Mount	
	<ul style="list-style-type: none"> • Fabric will measure ordered width less: $\frac{5}{8}$" • Head rail* will measure ordered width less: $\frac{1}{4}$" • Length will measure ordered length
Outside Mount	
	<ul style="list-style-type: none"> • Fabric will measure ordered width less: $\frac{1}{8}$" • Head rail* will measure ordered width • Length will measure ordered length
<p>* Head rail measurements include endcaps. Width and length measurements may vary +/- $\frac{1}{8}$"</p>	

NOTE: An additional $\frac{1}{4}$ " width deduction is taken on shades ordered Inside Mount with hold down brackets.

Applications

- Standard Rectangular
- Top Down - Bottom Up
- Two-On-One Head Rail
- Three-On-One Head Rail

Cord Loop Hardware System Features

Cord loops are available 18" to 10' lengths. Please specify length when ordering. Standard loop sizes are as follows:

Shade Length	Standard Loop
Up to 18"	18"
18" to 42"	2' (24")
42 $\frac{1}{8}$ " to 54"	3' (36")
54 $\frac{1}{8}$ " to 72"	4' (48")
72 $\frac{1}{8}$ " to 90"	5' (60")
90 $\frac{1}{8}$ " to 110"	6' (72")
110 $\frac{1}{8}$ " and greater	8' (96")

Ordering Information for Cord Loop Hardware Shades

Standard Rectangular

- Specify IB or OB mount, and left or right lift cord.
- Specify cord loop length when ordering.

Top Down - Bottom Up

- Specify IB or OB mount.
Specify cord loop length when ordering.
- Controls are the right cord loop lowers the middle rail and left cord loop raises the bottom. Reverse controls are not available.

Two-On-One Head Rail

- Two-On-One Head Rail Shades operate as two separate shades on one head rail.
- Specify IB or OB mount.
- Specify panel sizes.
- Specify cord loop length when ordering.
- See page 3 for maximum single panel width.
- $\frac{1}{4}$ " Space between panels.

**Prelude Cellular
CORDLESS ULTRA HARDWARE SYSTEM**

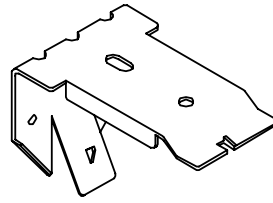

Standard Bracket

Prelude Hardware

Hardware Features	
Standard Hardware colors for Comfortex Prelude	Color coordinated head, middle and bottom rails.
Upgrades	
Fabric Wrapped Upgrade	Fabric used is same fabric as the shade. Back of rail is white to outside. End caps on fabric wrapped head, middle and bottom rails are color coordinated
Designer Metallic Upgrade	<ul style="list-style-type: none"> • Smooth faced Designer Oil Rubbed Bronze head, middle, bottom rails and end caps • Smooth faced Designer Brushed Nickel head, middle, bottom rails and end caps
Mounting Dimensions	
	Cordless Ultra Hardware System
Minimum Inside Mount	3/4"
Minimum Flush Inside Mount	2 1/8"
Minimum Outside Mount Flat Vertical Surface	1 1/2"
Maximum End Mount Shade width 48"	
Finished Dimensions	
Inside Mount	
	<ul style="list-style-type: none"> • Fabric will measure ordered width less: 3/8" • Head rail* will measure ordered width less: 1/4" • Length will measure ordered length
Inside Mount with Hold Down Brackets	
	<ul style="list-style-type: none"> • Fabric will measure ordered width less: 5/8" • Head rail* will measure ordered width less: 1/2" • Bottom rail* will measure ordered width less: 1/2" • Length will measure ordered length
Outside Mount	
	<ul style="list-style-type: none"> • Fabric will measure ordered width less: 1/8" • Head rail* will measure ordered width • Length will measure ordered length
End Mount/Side Mount	
	<ul style="list-style-type: none"> • Fabric will measure ordered width less: 5/8" • Head rail* will measure ordered width less: 1/2" • Length will measure ordered length
* Head rail measurements include endcaps. Width and length measurements may vary +/- 1/8"	

NOTE: An additional 1/4" width deduction is taken on shades ordered Inside Mount with hold down brackets.

Prelude Cellular CORDLESS ULTRA HARDWARE SYSTEM

Applications

- Standard Rectangular
- Top Down - Bottom Up
- Two-On-One Head Rail
- Three-On-One Head Rail

Ordering Information for Cordless Ultra Hardware Shades

Standard Rectangular

- Specify IB or OB mount.

Top Down - Bottom Up

- Specify IB or OB mount.

Accessories

- 5' Expandable Pole: \$37.00



Specially designed pole end fits into the handle on the bottom rail and allows for easy operation.

Things to Consider

- Is the top of your window out of reach? You can order an extension pole to reach but it can still be tricky. You may want to consider Cord Loop hardware.
- For shades mounted on doors, you may want to order hold down brackets.
- If privacy is an issue, consider Top Down-Bottom Up options.



**Prelude Cellular
CORDLESS LIFT & LOCK SHADES**



Prelude Hardware

Hardware Features	
Standard Hardware colors for Comfortex Prelude	Color coordinated head, middle and bottom rails with color coordinated push button/handle on the middle and/or bottom rails
Upgrades	
Fabric Wrapped Upgrade	Fabric used is same fabric as the shade. Back of rail is white to outside. All shades will have a white push button/handle on the middle /bottom rail. White end caps.

Mounting Dimensions	Standard Head Rail
Minimum Inside Mount	3/4"
Minimum Flush Inside Mount	2 1/8"
Minimum Outside Mount Flat Vertical Surface	1 1/2"
Maximum End Mount Shade width 48"	

Finished Dimensions	
Inside Mount	
	<ul style="list-style-type: none"> Fabric will measure ordered width less: 3/8" Head rail* will measure ordered width less: 3/16"
Outside Mount	
	<ul style="list-style-type: none"> Fabric will measure ordered width less: 1/8" Head rail* will measure ordered width
End Mount/Side Mount	
	<ul style="list-style-type: none"> Fabric will measure ordered width less: 1/2" Head rail* will measure ordered width less: 1/2"
* Head rail measurements include endcaps. Width and length measurements may vary +/- 1/8"	

NOTE: An additional 1/4" width deduction is taken on shades ordered Inside Mount with hold down brackets

Prelude Cellular CORDLESS LIFT & LOCK SHADES

Applications

- Standard Rectangular
- Top Down - Bottom Up
- Two-On-One Head Rail
- Three-On-One Head Rail

Ordering Information for Cordless Lift & Lock Hardware Shades Standard Rectangular

- Specify IB or OB mount and rail color.

Top Down - Bottom Up

- Specify IB or OB mount.

Things to Consider

- To operate a Cordless Lift & Lock Shade, the middle or bottom rails must be accessible. An extension pole is not available for Cordless Lift & Lock Shades.
- For shades mounted on doors, you may want to order hold down brackets.
- If privacy is an issue, consider Top Down-Bottom Up options.

Cordless Lift & Lock Shade Operation

Cordless Lift & Lock Shades are operated using the push button handle located in the center of the bottom rail.

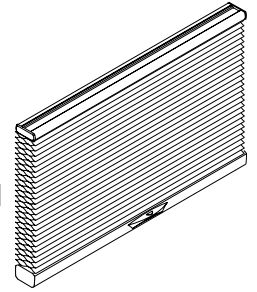

To raise or lower the shade; press the button on the shade handle, and guide the rail to desired position. Release the button to lock the shade into place.

The shade will hold in any position when the button is released. Raise the shade slowly and steadily to allow the shade to stack evenly.



**Prelude Cellular
SIMPLICITY MOTORIZED CELLULAR SHADES**

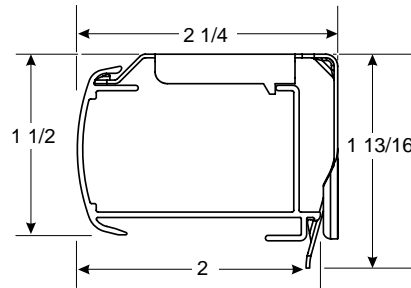

Simplicity Motorized Rail Dimensions

- Depth of rail: 2"
- Depth of rail and bracket: 1 1/2"
- Height of rail: 1 1/2"
- Height of bracket: 1 13/16"

Prelude Hardware

Hardware Features

Standard Hardware colors for Comfortex Prelude	Color coordinated head, bottom rails and end caps
Simplicity Remote	Upper and lower limit stops pre-programmed. "Favorites" position can be set on-site.

Upgrades

Fabric Wrapped Upgrade	Fabric used is same fabric as the shade. Back of rail is white to outside. End caps on fabric wrapped rails are color coordinated
Designer Metallic Upgrade	<ul style="list-style-type: none"> • Smooth faced Oil Rubbed Bronze head, middle, bottom rails and end caps • Smooth faced Brushed Nickel head, middle, bottom rails and end caps

Mounting Dimensions

Simplicity Motorized Hardware System

Minimum Shallow Mount	1"
Minimum Flush Inside Mount	2 1/4"
Minimum Outside Mount	7/8"
Minimum Side Mount	1 1/4"
Minimum Flush Side Mount	2 1/4"
Recommended Side Mounting Method	• Width limit for side mount brackets is 48"

Finished Dimensions

Inside Mount

- Fabric will measure ordered width less: 3/8"
- Head rail* will measure ordered width less: 1/4"

Outside Mount

- Fabric will measure ordered width less: 1/8"
- Head rail* will measure ordered width

Side Mount

- Fabric will measure ordered width less: 5/8"
- Head rail* will measure ordered width less: 1/2"

* Head rail measurements include endcaps. Width and length measurements may vary +/- 1/8"

Prelude Cellular SIMPLICITY MOTORIZED CELLULAR SHADES

Applications

- Standard Rectangular

Simplicity Motorization Surcharges

The standard Simplicity Motorized Lift System surcharge includes a 12 volt battery wand with eight AA batteries. Remotes are needed to operate the shades.

Important Simplicity Motorized Shade Operating and Installation Information

- Simplicity Motorized Shades installed into windows with metal casings may have a reduced radio frequency range, or may not operate at all, depending on the application.
- Do not let the antenna on the motor touch any metal objects. This may interfere with signals from the remote control.

Ordering Information for Motorized Cellular Shades

Simplicity Motor Option

- Specify IB or OB mount and rail color.
- Specify remote and other accessories if needed.

Motorized Cellular Blinds Warranty Simplicity Motors

See page 135

Simplicity Battery Wand

Batteries are needed to operate Simplicity motors. The battery wand can be clipped to the head rail or wall or ceiling mounted utilizing white battery wand clips. The 12 volt battery wand measures 17¼", and comes with eight AA alkaline batteries, and is white in color.

The battery wire is 10" long. A 48" extension wire is available.



Simplicity Motor Battery Life and Replacement

Eight alkaline batteries are included with the wand. The battery life will vary based on the type of window covering selected, the size and weight of the window covering and the number of times you operate the shade on a daily basis. For example, a 36" x 60" single honeycomb shade operated twice daily typically will have a battery life which lasts up to 18 months.

Comfortex will warranty batteries for up to 3 months from date of purchase.

Simplicity Hand Held Remotes

The 5 Channel remote can operate up to five shades individually or 5 groups. **WHEN ORDERING PLEASE SPECIFY WHICH CHANNELS ARE ASSIGNED TO EACH SHADE OR GROUP OF SHADES.** For example; program line 1 to channel 1, line 2 and 3 to channel 2, etc. If no channels are assigned at time of order, all shades will be programmed to Channel 1. **To reprogram channel assignments, please refer to the installation instructions and/or view the video at comfortex.com/comfortex-dealers.**



Simplicity remotes and holders are black in color. The remote comes with a holder which can be mounted to a wall for easy storage. The range of the remote is approximately 80 feet.

The 5C Simplicity remote utilizes one 3V battery (CR2032). Batteries are included. Comfortex will warranty batteries for up to 3 months from date of purchase.

DC Power Supply/Transformer

12 Volt DC power supply/transformer is available and requires a standard power outlet to power the motor. The transformer is an alternative to a battery wand. Each transformer can power a single shading. The power supply must plug in to the motor. The DC power supply is white and comes with a 80" wire. The dimensions are 1⅞" wide x 3¼" long x 1¼" deep



Prelude Cellular
RECHARGEABLE SIMPLICITY MOTORIZED CELLULAR SHADES

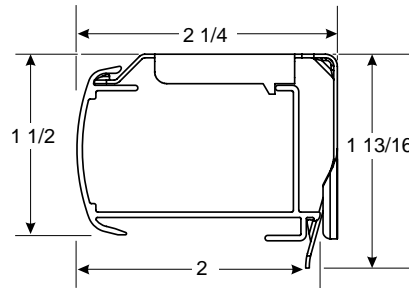

Rechargeable Simplicity Rail Dimensions

- Depth of rail: 2"
- Depth of rail and bracket: 2 1/4"
- Height of rail: 1 1/2"
- Height of bracket: 1 13/16"

Prelude Hardware

Hardware Features

Hardware colors for all Cellular and Pleated fabrics (Symphony Blackout Not Available)	Color coordinated head, bottom rails and end caps
Standard Hardware for all Custom Graphics	White head and bottom rails and end caps

Upgrades

Fabric Wrapped Upgrade	Fabric used is same fabric as the shade. Back of rail is white to outside. End caps on fabric wrapped head and bottom rails are color coordinated
Designer Metallic Upgrade	<ul style="list-style-type: none"> • Smooth faced Oil Rubbed Bronze head, bottom rails and end caps • Smooth faced Brushed Nickel head, bottom rails and end caps

Mounting Dimensions	Rechargeable Simplicity Motorization Hardware System
Minimum Shallow Mount	1/2"
Minimum Flush Inside Mount	2 1/4"
Minimum Outside Mount	7/8"
Minimum Side Mount	1 1/4"
Minimum Flush Side Mount	2 1/4"
Recommended Side Mounting Method	<ul style="list-style-type: none"> • See page 75 for recommended mounting method for side mount shades • Width limit for side mount brackets is 48"

Finished Dimensions

Inside Mount	
	<ul style="list-style-type: none"> • Fabric will measure ordered width less: 3/8" • Head rail* will measure ordered width less: 3/16"
Outside Mount	
	<ul style="list-style-type: none"> • Fabric will measure ordered width • Head rail* will measure ordered width plus: 3/16"
Side Mount	
	<ul style="list-style-type: none"> • Fabric will measure ordered width less: 7/8" • Head rail* will measure ordered width less: 1 1/16"
Exact (End Cap to End Cap) Mount	
	<ul style="list-style-type: none"> • Fabric will measure ordered width less: 3/16" • Head rail* will measure ordered width

* Head rail measurements include endcaps. Width and length measurements may vary +/- 1/8"

Prelude Cellular

RECHARGEABLE SIMPLICITY MOTORIZED CELLULAR SHADES

Rechargeable Simplicity Motors

The Simplicity Motor program features a battery powered motor utilizing a rechargeable battery hidden inside the shade head rail. Simplicity motors are compact and use a radio frequency remote to raise or lower the shades.

Rechargeable Motorized Lift Systems are not offered on sizes within the shaded area on the Standard Rectangular price grids.

Applications

- Standard Rectangular

EZ Level

Learn about the EZ Level feature on page 119.

Rechargeable Simplicity Motorization Surcharges

The Rechargeable Simplicity Motorized Lift System surcharge includes a rechargeable battery. Remotes are needed to operate the shades. Refer to pricing pages.

Important Simplicity Motorized Shade Operating and Installation Information

- Simplicity Motorized Shades installed into windows with metal casings may have a reduced radio frequency range, or may not operate at all, depending on the application.
- Do not let the antenna on the motor touch any metal objects. This may interfere with signals from the remote control.

RECHARGEABLE SIMPLICITY PRICING EXAMPLE:

Linen Weave	
Light Filtering 42" x 60" Shade:	\$364.00
Simplicity Rechargeable Surcharge:	\$334.00
Charger for Rechargeable :	\$27.00
Simplicity Remote Control:	\$40.00
Total List Price:	\$765.00

Simplicity Rechargeable Battery

The rechargeable battery is concealed in the head rail of the shade. A charger is required for the rechargeable battery. The rechargeable battery comes fully charged from the factory.



Charging Port on Back of Head rail.

Retrofit Existing Standard Simplicity Motorized Shades with Rechargeable Batteries

Cellular shades made with Standard Simplicity Motorization can be retrofitted with the Rechargeable Simplicity Motorization Battery Wand. The Rechargeable battery wand is 22" long, comes with 10 NiMH batteries, and is white in color. Battery wands are charged at the factory.

To retrofit the rechargeable battery wand to an existing shade with a cassette head rail, you must have at least 24" between bracket centerlines to fit the battery wand. Otherwise, the wand must be placed elsewhere along the window. Wall mounting clips are provided with the wand.

Retrofit Ordering Requirements:

- Rechargeable battery wand with clips (one per shade)
- Rechargeable battery charger (one or more per order, or as needed)
- Charge port mounting base (optional)

Please contact customer service for more information.



Battery Wand for Rechargeable Simplicity Retrofit

Prelude Cellular

RECHARGEABLE SIMPLICITY MOTORIZED CELLULAR SHADES

Simplicity Rechargeable Battery Life

Rechargeable batteries are included with the motor.

The average battery charge will last 6-12 months based on an average sized shade raised and lowered once per day. The life of the battery charge will vary based on the type of window covering selected, the size and weight of the window covering and the number of times the shade is operated on a daily basis.

The battery can be recharged up to 500 times. It takes approximately 5 hours to recharge the motor when fully depleted.

Ordering Information for Rechargeable Motorized Cellular Shades

Simplicity Motor Option

- Specify IB or OB mount and rail color.
- Specify remote and other accessories if needed.
- Specify one or more battery chargers.

Please Note:

- Not all motors run at the same rate of speed.
- Simplicity motors have a "Favorites" position setting. If the homeowner wants to set several shades at the same intermediate position, follow instructions provided with installation manual.
- Simplicity Rechargeable Motorized Cellular Shades are programmed at the factory with the "up and down" limits. The shades are **UNLINKED** from the remote so they are not able to operate during shipping. Each shade should be installed **after** linking it to the remote.
- **REMEMBER: Order at least one charger if ordering rechargeable motors.**

Simplicity Motorized Shade Warranty

Please see pages 134-135 for complete Comfortex warranty information.

Battery Charger

8.4 Volt charger requires a standard power outlet to recharge the battery wand. Must specify charger when ordering a Simplicity Rechargeable Wand Shade. The charger plugs into the charger port. The charger is black and comes with a 156" wire. The dimensions are 1" wide x 2½" length x 1¾" deep.



Simplicity Motor Hand Held Remotes 5 Channel Remote

The **5 Channel (5C) remote** can operate up to five shades individually or 5 groups. Simplicity Rechargeable Motorized Cellular Shades are programmed at the factory with the "up and down" limits. The shades are **UNLINKED** from the remote so they are not able to operate during shipping. Each shade should be installed **after** linking it to the remote.



Simplicity 5C remotes and holders are white or black in color. The remote comes with a holder which can be mounted to a wall for easy storage. The range of the remote is approximately 80 feet.

Simplicity Motor Hand Held Remotes Operation

Press the up or down button on the remote to raise or lower the shade to your desired position.

To reprogram channel assignments, please refer to the installation instructions and/or view the video at: comfortex.com/comfortex-dealers.

The Simplicity remotes utilize one 3V battery. Batteries are included. Comfortex will warranty batteries for up to 3 months from date of purchase. Batteries are not covered by the warranty.

Solar Panel Recharge Option

Plugs in to any Simplicity Rechargeable Remote control shade (does not work with PowerTouch)

Provides constant trickle charge to 7.4v Li-Ion Rechargeable battery packs. Does not require direct sunlight, but performs best in regular direct sunlight applications. Will prolong the life of the charge of the 7.4v rechargeable battery packs, and in some applications will maintain charge indefinitely.

Life of charge is subject to application variables such as, size and weight of shade, frequency of use, amount of direct sunlight exposure, etc.



Dimensions of panel
18½" x 1½"

**Prelude Cellular
POWERTOCH RECHARGEABLE MOTORIZED CELLULAR SHADES**

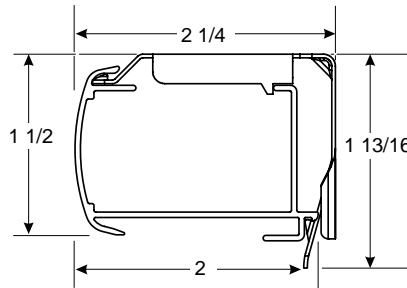

Simplicity Motorized Rail Dimensions

- Depth of rail: 2"
- Depth of rail and bracket: 2 1/4"
- Height of rail: 1 1/2"
- Height of bracket: 1 13/16"

Hardware Features	
Hardware colors for all Cellular and Pleated fabrics	Color coordinated head, bottom rails and end caps
Standard Hardware for all Custom Graphics	White head and bottom rails and end caps
Simplicity Remote	Upper and lower limit stops pre-programmed, Intermediate stop "favorites" position available

Upgrades	
Fabric Wrapped Upgrade	Fabric used is same fabric as the shade. Back of rail is white to outside. End caps on fabric wrapped head and bottom rails are color coordinated
Designer Metallic Upgrade	<ul style="list-style-type: none"> • Smooth faced Oil Rubbed Bronze head, bottom rails and end caps • Smooth faced Brushed Nickel head, bottom rails and end caps

Mounting Dimensions	Simplicity Motorized Hardware System
Minimum Shallow Mount	1/2"
Minimum Flush Inside Mount	2 1/4"
Minimum Outside Mount	7/8"
Minimum Side Mount	1 1/4"
Minimum Flush Side Mount	2 1/4"
Recommended Side Mounting Method	<ul style="list-style-type: none"> • See page 75 for recommended mounting method for side mount shades • Width limit for side mount brackets is 48"

Finished Dimensions	
Inside Mount	
	<ul style="list-style-type: none"> • Fabric will measure ordered width less: 3/8" • Head rail* will measure ordered width less: 3/16"
Outside Mount	
	<ul style="list-style-type: none"> • Fabric will measure ordered width • Head rail* will measure ordered width plus: 3/16"
Side Mount	
	<ul style="list-style-type: none"> • Fabric will measure ordered width less: 7/8" • Head rail* will measure ordered width less: 1 1/16"
Exact (End Cap to End Cap) Mount	
	<ul style="list-style-type: none"> • Fabric will measure ordered width less: 3/16" • Head rail* will measure ordered width

* Head rail measurements include endcaps. Width and length measurements may vary +/- 1/8"

Prelude Hardware

Prelude Cellular

POWERTOCH RECHARGEABLE MOTORIZED CELLULAR SHADES

PowerTouch™ Rechargeable Shades

Cellular Shades can be fabricated with the PowerTouch Rechargeable Push Button Control option. The PowerTouch Rechargeable option is an easy, cord free motorized operation for the budget savvy homeowner. PowerTouch Rechargeable uses Simplicity motors and components.

PowerTouch Rechargeable Shades Operation

Press the up or down button on the pendant to raise or lower the shade to your desired position.

No programming is required with PowerTouch™, all programming is set at the factory. Upper and lower limits easily can be adjusted in the field if desired. Please refer to the installation instructions at comfortex.com/ comfortex-dealers. A "favorites" or intermediate stop position can be set once installed.

PowerTouch Rechargeable Surcharges

See page 9.

PowerTouch Appearance

- The PowerTouch wand and pendant is attached to the head rail when installed.
- The wand and pendant hangs down the front of the shades from the head rail. The wand does not touch the fabric.
- Pendant is 2½" long.
- The pendant does not need to be mounted to the wall to operate the shade.



PowerTouch Rechargeable Color Options

- Shades with Black or Oil Rubbed Bronze hardware will be built with black wand and pendants standard. All other colors will use white wand and pendants.



White



Black Shown with Plug-In Charger

PowerTouch Wand and Pendant Location

The standard location for the wand and pendant is on the right. Please specify location when ordering.

PowerTouch Rechargeable Wand Length

- The standard length of the wand will measure the indicated below unless otherwise specified.

Shading Length	Standard Wand Length
Up to 30"	1' (12")
>30" to 52"	2' (24")
>52" to 78"	3' (36")
>78" to 100"	4' (48")
>100" to 120"	5' (60")

Mounting Requirements for PowerTouch Rechargeable Shades

- No special installation hardware or wiring requirements are needed.

Battery Charger

8.4 Volt charger requires a standard power outlet to recharge the battery wand. Must specify charger when ordering a Simplicity Rechargeable Wand Shade. The charger plugs into the charger port. The charger is black and comes with a 156" wire. The dimensions are 1" wide x 2½" length x 1¾" deep.



PowerTouch Rechargeable Shades Warranty

Please see page 135 for complete warranty information.

Prelude Cellular OVATION CELLULAR SLIDER

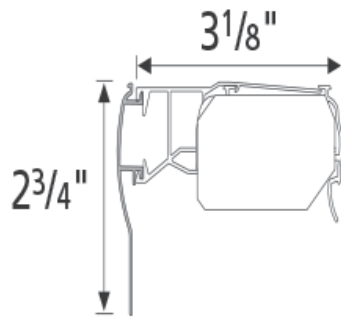

Ovation Hardware Rail Dimensions

- Depth of rail and bracket: 3 1/8"
- Valance Height: 2 3/4"
- For each spacer block 1/2" will be added to the length of the valance returns. For extension brackets, 2" will be added unless otherwise instructed.

Hardware Features	
Standard Hardware colors for Comfortex Prelude	Coordinating rail colors have been preselected for each fabric. More colorful fabrics are coordinated to white and off-white rail colors.
Ovation Valance	Every Ovation Slider comes with a painted aluminum valance. The valance attaches to the head rail using a durable plastic clip system.
Mounting Dimensions	
Minimum Inside Mount, Installation Bracket	1 5/16"
Minimum Flush Mount	3 5/8"
Minimum Outside Mount	5/8"
Mounting Specs	
	<ul style="list-style-type: none"> • For each spacer block, 1/2" will be added to the length of the valance returns. For extension brackets, 2" will be added unless otherwise instructed. • Specify Inside Mount (IB) or Outside Mount (OB) when ordering. If the slider requires a non-flush inside mount, you must order a custom valance. • Exact valance width and exact valance return length (minimum 1 1/2") must be specified in the Special Instructions section of the order form.
Finished Dimensions	
Inside Flush Mount	
Track Width:	
Right or Left Stack	3/16" less than ordered width
Split Stack	3/16" less than ordered width
Center Stack	3/16" less than ordered width
Finished Slider Length	1/2" less than ordered width
Valance	3/16" less than ordered width
Outside Mount	
Track Width	3/16" less than ordered width
Finished Slider Length	Ordered length - No reductions will be made
Valance	Ordered width plus 1"
Valance Returns	Will measure 3 1/8" (standard)

Prelude Hardware

Prelude Cellular

OVATION CELLULAR SLIDER

Applications

- Standard Rectangular
- Opens and closes from side to side
- Four stacking options - see below.

Ovation Stacking Width

Width	up to 84"	up to 96"	up to 108"	up to 120"
Stack	6½"	7¼"	8"	8¾"

Minimum Ovation Stack

Ovation's fabric stack measures 6½" regardless of the ordered width. Fabric stacking dimensions are determined by the slider's hardware, not ordered width.

Things to Consider

- Since most Ovations are sold in large sizes, the shade will have a large fabric stack. On an outside mount, you may want to order the shade a few inches wider so that the fabric stack can be clear of the window.

Ordering Information for Ovation Cellular Sliders

- Specify IB or OB mount.
- Specify stacking configuration.
On Split Stack Shades, both panels will be of equal width unless specified.
- Specify valance width and return length.

Ovation Valance Specifications

- Every Ovation Slider is supplied with a painted aluminum valance.
- The valance attaches to the head rail using a durable plastic clip system.

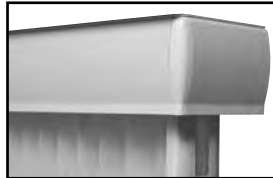

Ovation Valance Dimensions

All valance dimensions are measured on the flat, back side.

- Valance Height: 2¾"
- Standard Return Length (OB only): 3⅛"
- For each spacer block, ½" will be added to the length of the valance returns. For extension brackets, 2" will be added unless otherwise instructed.

Vertical Stacking Options

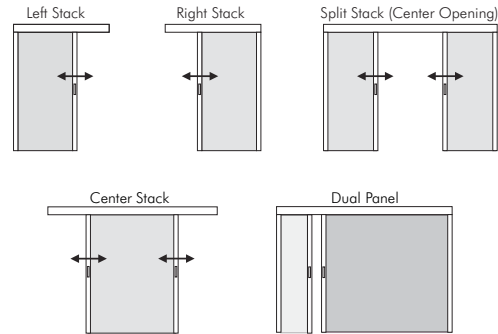

Specify stacking configuration when ordering.

Left: Fabric stacks to the left side of the slider.

Right: Fabric stacks to the right side of the slider.

Center Stack: Center Stack Sliders fabric panels can move fully to the left or the right.

Split Stack: Fabric is split in the center of the slider forming two equal panels which open to opposite ends of the slider. Both panels will be of equal width unless otherwise specified.



Prelude Cellular STARBURST ARCHES

Stationary Starburst

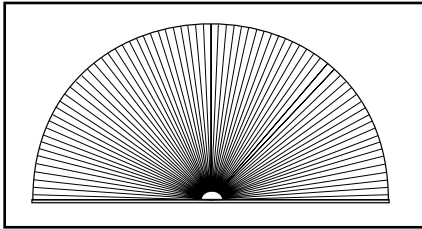

Figure A

Movable Starburst

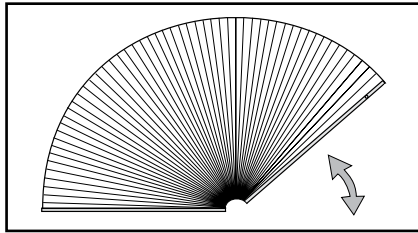

Figure B

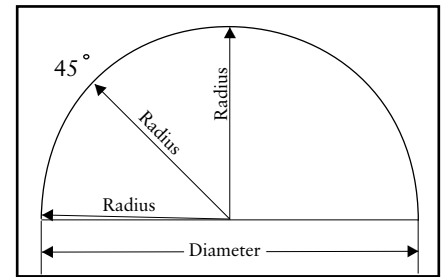

Figure C

Hardware Features	
Standard Hardware colors for Comfortex Prelude	Color coordinated rails
Mounting Dimensions	
Minimum Shallow Mount	3/4"
Minimum Flush Inside Mount	2 3/8"
Recommended Side Mounting Method	• Width limit for side mount brackets is 48"
Finished Dimensions	
Inside and Side Mount	
<ul style="list-style-type: none"> Fabric will measure ordered width less: 3/8" Head rail* will measure ordered width less: 3/16" 	<ul style="list-style-type: none"> * Head rail measurements include endcaps. Width and length measurements may vary +/- 1/8"

Prelude Hardware

Applications

- Stationary Fan Style Arch
 - Movable Fan Style Arch
- Movable Starburst Arch shades are for inside and shallow mount applications only.

Stationary Starburst Features (Figure A)

- All non-perfect Stationary Starburst arches require a template. See page 131 to for template instructions.
- All templates should be made from brown craft paper. Comfortex offers template kits. Please contact Customer Service to order. Stock number: 751000
- A perfect arch is twice as wide as it is high.
- Stationary Starburst shades which are not perfect half circles must have a height that equals half the width +/- 5".
- Price according to the largest radius measurement. If the height is greater than the width, take height X 2 and use that number to determine pricing.
- When ordering arches as perfect half-circles make sure the radius of the arch remains constant to ensure a proper fit. (See Figure C)

Movable Starburst Features (Figure B)

- Starburst Movable archtop shades are cut to perfect half circles only and do not require a template. The height must be exactly 1/2 the diameter.
- A perfect arch is twice as wide as it is high.
- When ordering arches as perfect half circles make sure the radius of the arch remains constant to ensure a proper fit. (See Figure C)
- The hinge gap (gap between the two rails) is not centered in the window. The moving rail is always smaller than the stationary rail to provide proper movement within the window.

Ordering Information for Sunset Shades

- Specify IB mount and rail color.
- Include a template if the shade is a non-perfect arch.

Accessories

- 6' Expandable Pole: \$37.00

Specially designed pole end fits into the handle on movable Starburst Shades for easy operation.



Prelude Cellular SUNSET ARCHES

Movable Sunset

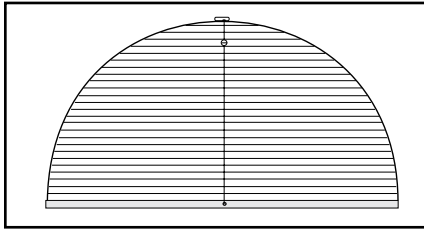

Figure A

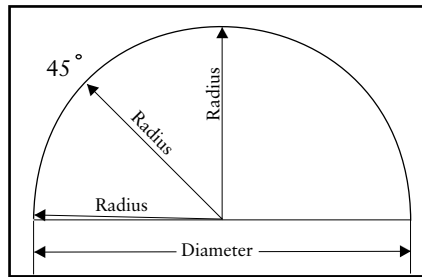

Figure B

Two-String Hanging Method

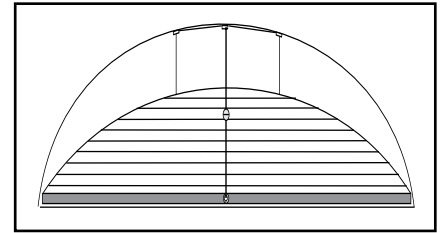

Figure C

Prelude Hardware

Hardware Features | See Page 94 for Rail Dimensions

Hardware colors for all Prelude	Color coordinated head, middle and bottom rails with white cord and silver tassel
---------------------------------	---

Mounting Dimensions	Standard Rail
Minimum Shallow Mount	3/4"
Minimum Flush Inside Mount	2 3/8"
Minimum Side Mount	1 3/8"
Minimum Flush Side Mount	1 7/8"
Recommended Side Mounting Method	<ul style="list-style-type: none"> • See page 113 for recommended mounting method for side mount shades • Width limit for side mount brackets is 48"

Finished Dimensions

Inside and Side Mount	
	<ul style="list-style-type: none"> • Fabric will measure ordered width less: 3/8" • Head rail* will measure ordered width less: 3/16"
Outside Mount	
	<ul style="list-style-type: none"> • Is not offered for Prelude Sunset Top-Down Arches

* Head rail measurements include endcaps.
Width and length measurements may vary +/- 1/8"

Applications

- Movable Arch

Ordering Information for Sunset Shades

- Include a template if the shade is a non-perfect arch.

Accessories

- 6' Expandable Pole: \$37.00

Specially designed pole end fits into the ball on Sunset Shades for easy operation.



Prelude Cellular SUNSET ARCHES

Sunset Features and Ordering Notes (Figure A)

- Sunset shades have horizontal pleats that stack at the bottom, on a stationary sill rail. Sunset shades are operated by a continuous cord that runs through a top mount guide block and back down through the stationary rail. A moving metal ball attached to the cord is used to raise and lower the shade. (See Figure D).
- **All Sunset arches require a template.** A perfect arch is twice as wide as it is high. See page 131 for template instructions.
- **All templates should be made from brown craft paper.** Comfortex offers template kits. Please contact Customer Service to order. Stock number: 751000
- Sunset shades which are not perfect half circles must have a height which is equal to or greater than 25% of the width.
- When ordering Sunset shades that are perfect half circles, make sure the radius of the arch remains constant to ensure a proper fit. (See Figure B).
- **Stringing Method:** Depending on the curvature of a particular arch, it may be necessary to use the two string method (See Figure C) to ensure proper fit and operation of your Sunset shade. Comfortex will determine the best stringing method after examination of the template.

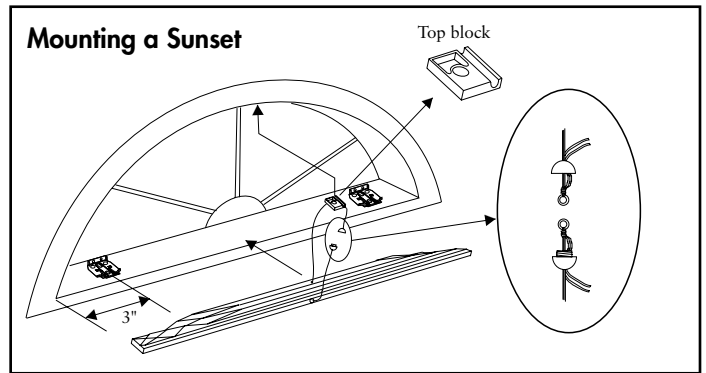

Figure D

Recommended Mounting Method for Side Mounting Shades

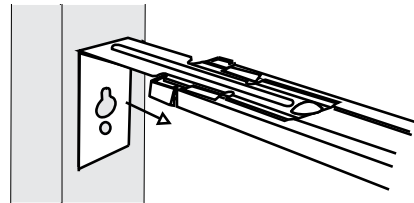

Figure F

Refer to the installation instructions on Comfortexdealers.com or the OnDemand Mobile Library for further details on side mounting shades.



Prelude Cellular QUARTER ROUNDS

Stationary Quarter Round

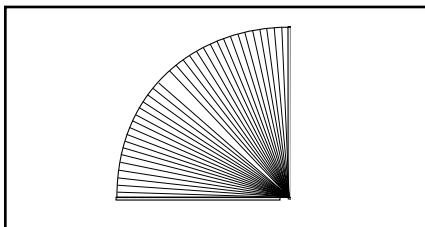

Figure A

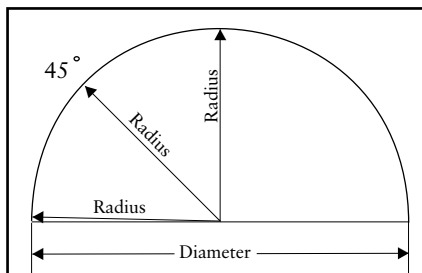

Figure B

Prelude Hardware

Hardware Features	
Hardware colors for all Cellular and Pleated fabrics	Color coordinated rails
Mounting Dimensions	
Minimum Shallow Mount	3/4"
Minimum Flush Inside Mount	2 3/8"
Minimum Outside Mount	3/4"
Minimum Side Mount	1 3/8"
Minimum Flush Side Mount	1 7/8"
Recommended Side Mounting Method	<ul style="list-style-type: none"> • See page 113 for recommended mounting method for side mount shades • Width limit for side mount brackets is 48"
Finished Dimensions	
Inside and Side Mount	
	<ul style="list-style-type: none"> • Fabric will measure ordered width less: 3/8" • Head rail* will measure ordered width less: 3/16"
Outside Mount	
	<ul style="list-style-type: none"> • Fabric will measure ordered width • Head rail* will measure ordered width plus: 3/16"
Exact (End Cap to End Cap) Mount	
	<ul style="list-style-type: none"> • Fabric will measure ordered width less: 3/16" • Head rail* will measure ordered width
* Head rail measurements include endcaps. Width and length measurements may vary +/- 1/8"	

Applications

- Stationary Fan Style Quarter Round

Ordering Information for Quarter Rounds Shades

- Specify IB or OB mount and rail color.

Quarter Rounds Features

- Price according to the largest radius measurement.
- **All templates should be made from brown craft paper.** Comfortex offers template kits. Please contact Customer Service to order. Stock number: 751000
- When ordering arches as perfect quarter circles, make sure the radius of the arch remains constant to ensure a proper fit. (See Figure B)

Prelude Cellular TRAPEZOIDS AND OCTAGONS

Movable Trapezoids

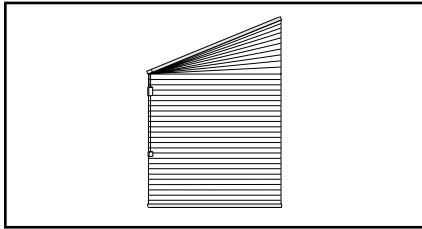

Movable Octagons

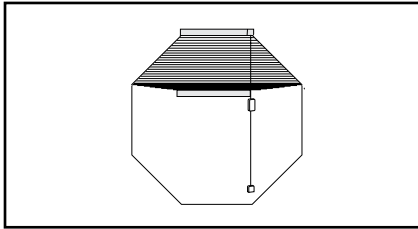

Hardware Features See Page 94 for Rail Dimensions	
Standard Hardware colors for Comfortex Prelude	Color coordinated head and bottom rails with white cord and tassel
Mounting Dimensions	
Minimum Shallow Mount	3/4"
Minimum Flush Inside Mount	2 3/8"
Minimum Outside Mount	3/4"
Minimum Side Mount	1 3/8"
Minimum Flush Side Mount	1 7/8"
Recommended Side Mounting Method	<ul style="list-style-type: none"> • See page 113 for recommended mounting method for side mount shades • Width limit for side mount brackets is 48"
Finished Dimensions	
Inside and Side Mount	
	<ul style="list-style-type: none"> • Fabric will measure ordered width less: 3/8" • Head rail* will measure ordered width less: 3/16"
Outside Mount	
	<ul style="list-style-type: none"> • Fabric will measure ordered width • Head rail* will measure ordered width plus: 3/16"
Exact (End Cap to End Cap) Mount	
	<ul style="list-style-type: none"> • Fabric will measure ordered width less: 3/16" • Head rail* will measure ordered width
* Head rail measurements include endcaps. Width and length measurements may vary +/- 1/8"	

Prelude Hardware

Applications

- Movable Trapezoids
- Movable Octagons

Ordering Information for Trapezoid Shades

- Specify IB or OB mount and rail color.
- **Trapezoid orders must be faxed in with a diagram. Please provide measurements for all four sides when ordering.**

Ordering Information for Octagon Shades

- Specify IB or OB mount and rail color.
- **The width, length and one side are required measurements when ordering.**

Prelude Cellular TRAPEZOIDS AND OCTAGONS

Trapezoids (Figure A)

- Trapezoid orders must be faxed in with a diagram. Please provide measurements for all four sides when ordering. Template is required.
- The maximum slope of the top rail is 30 degrees from horizontal. Slope is the angle between slope and a horizontal line. The slope angle must be measured with a protractor.
- Sides of trapezoid must be parallel.
- Sill must be level for proper installation and operation of a trapezoid shade.
- Operating cord must be placed on the short side.
- See Figure B for trapezoid shade operation.

Octagons

- The width, length and one side are required measurements when ordering.
- Octagon shades raise only to the point where the top angle begins. (See Figure C)

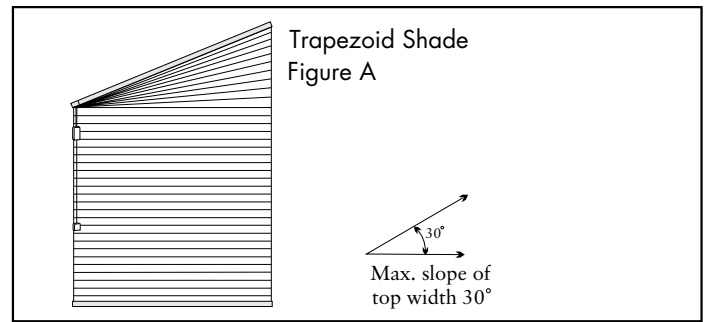

Trapezoid Shade Operation

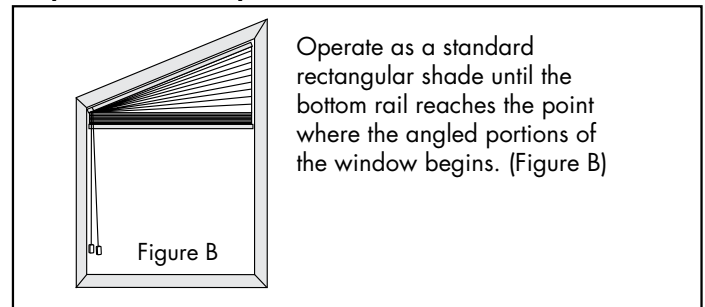

Octagon Operation

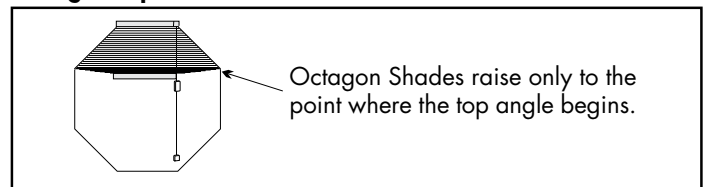
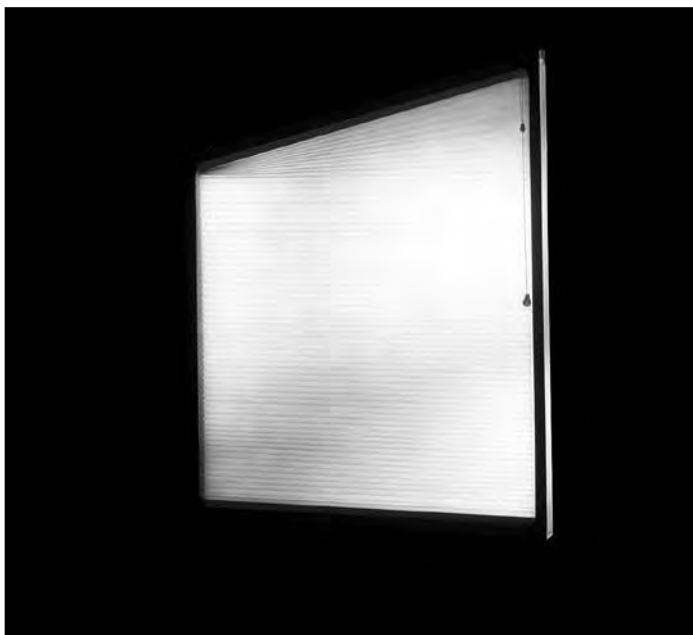
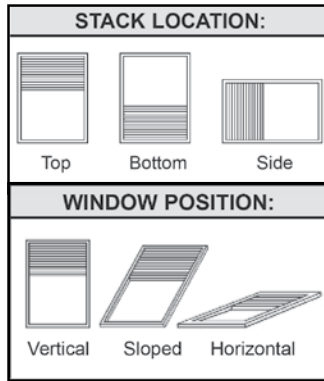
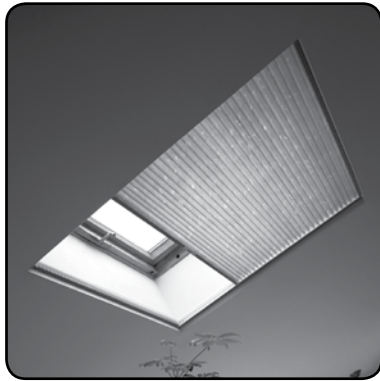

Figure C



Prelude Cellular SKYLIGHT SHADING SYSTEM



Skylight Vertical Applications

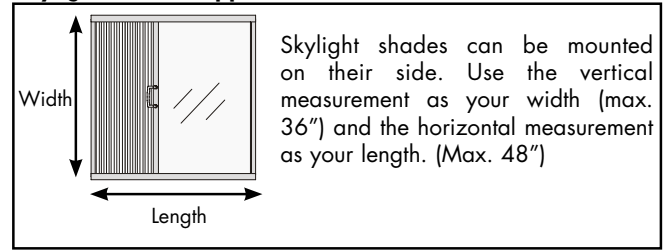

Figure A

Hardware Features	
Standard Hardware colors for Comfortex Prelude	White head and bottom rails with white cord in a white sidetrack.
Upgrades	
Fabric Wrapped Upgrade	Not Available
Designer Metallic Upgrade	Not Available
Mounting Dimensions - Inside Only	
Skylight Shading System	
Minimum required for installation	1 1/4"
Minimum Flush Inside Mount (Rail Fully Recessed)	2 1/2"
The widest width of the window cannot exceed the narrowest width of the window by more than 3/8".	
Finished Dimensions	
Inside Mount	
	<ul style="list-style-type: none"> Fabric will measure ordered width less: 3/4" Head rail* will measure ordered width less: 3/16"
* Head rail measurements include endcaps. Width and length measurements may vary +/- 1/8"	

Applications

- Horizontal, Angled and Vertical rectangular windows and skylights. Skylight Shading Systems are for inside mount applications only.

Ordering Information for Skylight Shading System

- Specify when ordering: Application angle: Angled, Horizontal or Vertical.

Accessories

- 6' Expandable Pole: \$37.00



Specially designed pole end fits into the handle of Skylight shades for easy operation at any angle.

Skylight Shading System Features

- Shades can be mounted on their side. (See Figure A). Use the vertical measurement as your width (max. 36") and the horizontal measurement as your length (max. 48").
- Track system provides superior insulation and light blocking. The enclosed sides provide full privacy.
- Shades over 30" wide require support cords.
- Fabric gasket attached to moving rail to eliminate light leakage when shade is closed.

Cellular Shade Options

HIGHLIGHTS CORNICE VALANCE



Highlights Cornice Valances

Elevate your windows to a whole new level of design with the Highlights Cornice Valance. Coordinate with other design elements in your room. Add a finishing touch to the top of any window treatment.

The Highlights Cornice Valance is versatile and beautiful at a price point that won't leave you wondering how to cover the rest of your windows!

Choose from any fabric in our Envision™ and PERSONA™ line and customize the valance with our 7 available return sizes to best fit your application.

Easy assembly and quick installation, with the Highlights Cornice Valance, more beautiful windows are within your reach.

Refer to your Envision price list for pricing and specifications.



Fabric Characteristics

Natural Linen Flax Cellular Fabric Characteristics

Natural Linen Flax fabrics are sheer and are created from flax fibers which allow the most amount light into the room. Interior shade cords and objects in the room may be clearly seen through the shades.

Variations in the fabric weave, slubs, and texture are all enhancements that add to the natural beauty and character of the shade; therefore no two shades will look exactly the same.



Weave

Slub

Texture

Cut-Outs

Cut-outs are available with all cellular fabrics. Cut-outs are \$52.00 per side and are subject to approval by the Comfortex Technical Service department.

There are no limits on cut out lengths. There are limits on cut out widths:

Cellular shade widths 18" or less	3" maximum width
Cellular shade widths greater than 18"	5" maximum width
Pleated shades	2" maximum width

Scotchgard™ and Certified Fabrics

Scotchgard Protection

Scotchgard™ Protector is available with all cellular Shades. Scotchgard™ keeps your shades looking newer, fresher and cleaner longer.



A combination of the latest advances in stain release and repellency provides exceptional stain protection. Spills wipe away easily and most dirt and stains lift out when cleaned. Both sides of the fabric are treated with Scotchgard.

Greenguard Certified Fabrics

GREENGUARD Indoor Air Quality Certified® Fabrics
The GREENGUARD Environmental Institute has established performance based standards to define goods with low chemical and particle emissions for use indoors.

The following fabrics have the passed GREENGUARD Indoor Air Quality Certified® certification program for low emitting interior building materials, furnishings, and finish systems:

- Symphony (All)
- Virtuoso (All)
- Baritone (All)
- Premiere (All)
- Natural Linen Flax
- Debut (All)
- Linen Weave

The following fabrics have the passed GREENGUARD Children & SchoolsSM product certification program for low emitting interior building materials, furnishings, and finish systems used in educational (day care and K-12) environments:

- Symphony Light Filtering
- Symphony Blackout

Symphony Flame Resistant Fabrics

Symphony Flame Resistant Fabrics have been registered as a Flame Resistant Products by the California State Fire Marshall for products identified in section 13115, California Health and Safety Code (California CHSC). Copies of the certificates are located on the Comfortex.com/comfortex-dealers web site or on the On Demand Mobile library.

Color Selection

Use the current Cellular Shades Collection sample book to select colors from the Symphony light filtering fabric collection. All thirty colors are available in 3/8" Symphony light filtering double cell and 3/4" light filtering single cell.

Ordering Flame Resistant Shades

The SKU structure for Symphony Flame Resistant material is: 3012 05 XXX (XXX representing the color number).

To order Symphony Flame Resistant Shades: Use the SKU number listed on the decks.

The SKU structure for the 3/4" Symphony Flame Resistant material is: 2512 05 XXX

To order 3/4" Symphony Flame Resistant Shades:

Use the Symphony three digit color number to identify your desired color.

In this example:
2512 05 108



EZ Level on Comfortex Cellular Shades

EZ Level makes quick work of leveling without cords to cut or tuck into a rail. No special tools needed – just use a nickel, quarter or penny to adjust plug on the bottom rail.

EZ Level is standard on all Cellular and Pleated Shades with the following hardware systems:

- Standard and Deluxe Cord Lock
- Cordless Ultra
- Cord Loop
- SlumberShades
- Simplicity Motorized Systems

EZ Level is not available with Lift & Lock Cordless.

How does EZ Level work?

- Slightly raise the bottom rail you want to level.
- Insert a coin or flat head screwdriver into the adjustment screw and turn it.
- Turn the adjustment screw clockwise or counter clockwise to make slight adjustments up or down.



One quarter turn of the adjustment screw will move the bottom rail up or down 1/4".

- Lower the rail to check the level and make further adjustments if necessary.

Cleaning and Care

While beautiful and pleasing to the eye, all Comfortex products are designed to be durable, easily cared for and easily cleaned. Our non-woven fabrics are inherently anti-static and repel dust, but occasional feather dusting or vacuuming may be necessary to keep the fabrics clean and bright. Comfortex Cellular fabrics may be ultrasonically cleaned.

Cleaning Virtuoso Blackout, Baritone Blackout and Symphony Blackout Fabrics:

Our blackout fabrics are inherently anti-static and repel dust, but occasional cleaning may be necessary to keep the fabrics clean and bright. The fabric can be dusted with a soft, clean cloth, feather duster or lightly vacuumed with a soft brush attachment. To spot clean, use a cloth or sponge dipped in a light solution of lukewarm water and clear dish detergent and lightly dab. Do not scrub the surface. Rinse thoroughly.

Cleaning all other Comfortex Cellular or Pleated Fabrics:

Our light filtering and room darkening fabrics are inherently anti-static and repel dust, but occasional cleaning may be necessary to keep the fabrics clean and bright. The fabric can be dusted with a soft, clean cloth, feather duster or lightly vacuumed with a soft brush attachment. Spills and stains can be lightly blotted with a cloth or damp sponge. More difficult stains may require soaking in water with mild soap. For this, remove the shades from the window and soak in warm water. Complete immersion of hardware is not recommended.

DO NOT submerge the Cordless Ultra head rail in water. When damp, lay flat to dry or place back in window and raise tightly to recrisp pleats. Please test any stronger cleaners on an unobtrusive portion of the shade before using.

For additional advice on care or cleaning, please contact our Technical Services Department.

Scotchgard™ Treated Shades

The following are the recommended cleaning and care instructions for window treatments with fabric treated with Scotchgard™ Protector.

- Gently blot liquid stains immediately with a clean, white cloth.
- If stain remains, prepare a solution of ¼ teaspoon of clear, non-bleaching dish detergent mixed with 1 cup of lukewarm water. Dampen a clean white cloth and gently blot the stain.
- Do not overwet the fabric or excessively rub the stained area.
- See the Installation and Care instructions for complete details.



For additional assistance with stain removal, call the Scotchgard™ Protector Service Center at 1-800-433-3296. Customer Care representatives are available Monday through Friday, 8am to 6pm CT.

Odysee Cellular Blinds

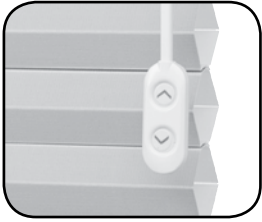
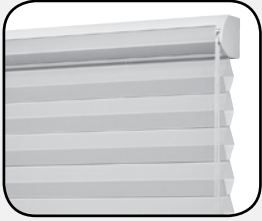

Odysee Cellular Blinds

Odysee Cellular Blinds Hardware Options

	Key Features	Color Options	Hardware Size (Depth x Height)	Shade Size Available	More Information
<p>PowerTouch™ Cordless Motorized Wand</p> 	<ul style="list-style-type: none"> • Child safe • NiMH Rechargeable Battery Wand • Standard on shades up to 72" x 84" 	<ul style="list-style-type: none"> • White Head & Bottom Rails • Color matched fabric head rail insert strip 	<p>Head Rail: 2½" x 2½"</p> <p>Bottom Rail: 1¼" x ½"</p>	<p>Width: 20" to 72"</p> <p>Length: 12" to 84"</p>	Page 126
<p>Cord Loop</p> 	<ul style="list-style-type: none"> • Integrated clutch locking system • Cord Loop makes operation easy • Smooth & quiet operation 	<ul style="list-style-type: none"> • White Head & Bottom Rails • Color matched fabric head rail insert strip 	<p>Head Rail: 2½" x 2½"</p> <p>Bottom Rail: 1¼" x ½"</p>	<p>Width: 20" to 108"</p> <p>Length: 12" to 120"</p>	Page 124
<p>Simplicity Motorization</p> 	<ul style="list-style-type: none"> • Raise & lower shade with a click of a button • Great for large and hard to reach windows • Remote can operate multiple blinds 	<ul style="list-style-type: none"> • White Head & Bottom Rails • Color matched fabric head rail insert strip 	<p>Head Rail: 2½" x 2½"</p> <p>Bottom Rail: 1¼" x ½"</p>	<p>Width: 20" to 96"</p> <p>Length: 12" to 96"</p> <p>Maximum Area: 50 Sq. Ft.</p>	Page 127

Odysee Cellular Blinds

Odysee Cellular Blinds Features at a Glance

- Odysee Insulating Blinds provide the same energy saving benefits as classic cellular shades, but with the enhanced versatility of fully functional vanes.
- The Odysee vanes expand and compress to create several innovative views. Expanded vanes offer complete privacy, energy efficiency and hidden lift cords. Compressed vanes provide variable light control and substantial view through -like a wood blind.
- All Odysee Blinds are built with a PowerTouch™ system as standard.
- Odysee vanes are available with light filtering or room darkening fabric.
- Odysee provides the convenient operation of a blind with soft fabric look of a shade.
- All Odysee vanes are white to the outside for a uniform exterior appearance.
- A limited lifetime warranty serves as a commitment to your satisfaction.

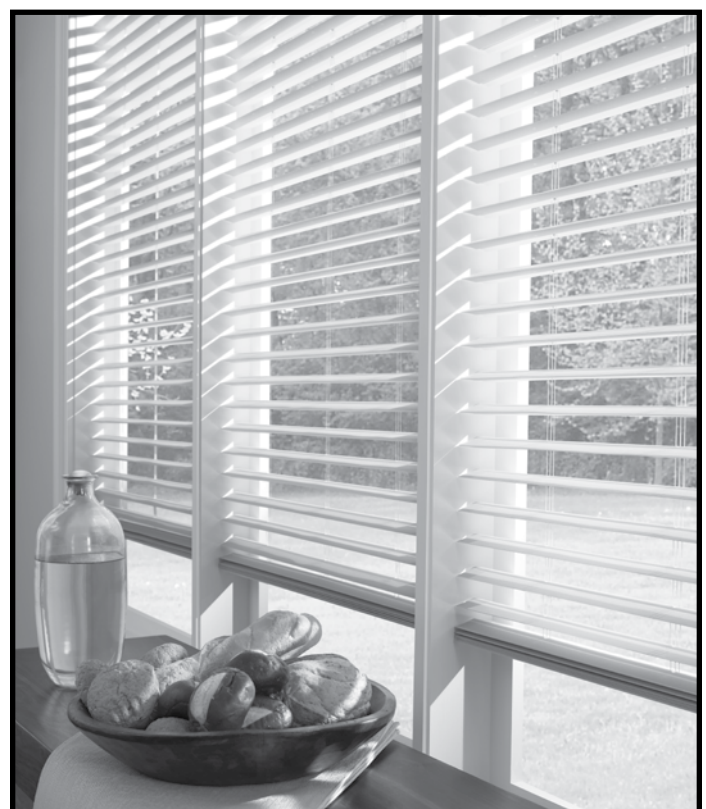

Odysee Cellular Blinds
Separate Discount Applies

PRICE GROUP 40
PowerTouch™ or Cord Loop System -
Light Filtering

		Width In Inches														
		24	30	36	42	48	54	60	66	72	78	84	90	96	102	108
Length In Inches	36	341	384	435	489	540	579	631	685	733	782	833	881	940	993	1049
	42	369	419	475	540	591	648	702	763	818	875	933	989	1049	1111	1175
	48	387	450	513	575	638	697	762	821	887	947	1006	1073	1140	1208	1278
	54	408	473	542	612	685	744	815	885	948	1015	1082	1156	1227	1301	1376
	60	445	509	588	657	735	812	883	956	1031	1110	1185	1259	1335	1414	1493
	66	471	545	628	708	793	875	950	1033	1115	1201	1283	1374	1450	1537	1623
	72	494	570	660	759	840	918	1017	1092	1185	1271	1357	1464	1542	1634	1726
	78	526	612	708	806	903	982	1072	1171	1265	1360	1455	1554	1654	1754	1851
	84	547	648	744	849	950	1037	1135	1239	1341	1449	1546	1645	1750	1855	1961
	90	573	677	790	891	1005	1096	1205	1317	1424	1534	1640	1752	1863	1974	2085
	96	596	708	820	937	1057	1151	1264	1380	1493	1609	1725	1843	1961	2077	2197
	102	685	791	893	1010	1115	1206	1346	1476	1579	1683	1791	1944	2052	2176	2296
108	720	833	941	1063	1173	1268	1413	1552	1662	1779	1884	2031	2140	2269	2398	
114	763	881	1000	1128	1251	1347	1498	1645	1763	1881	2000	2153	2270	2406	2542	
120	818	944	1072	1205	1331	1443	1602	1763	1887	2012	2141	2305	2433	2577	2720	

Simplicity Motorized Lift System is not offered within the shaded area.
 Sizes up to 72" width by 84" length are built as PowerTouch™ Cordless Motorized Wand unless otherwise specified.

LIFT SYSTEM AND DESIGN UPGRADES		ADD
Solid Colors and Natural Texture Collection Fabrics	Light Filtering	Grid 40
	Room Darkening	10% to Grid 40
Personal Color System Fabrics	Light Filtering	10% to Grid 40
	Room Darkening	10% to Grid 40 PLUS 10%
Cord Loop Option		Pg 125 FREE
MOTORIZATION		MORE INFO
		ADD
Custom PowerTouch Wand length		Pg 126 \$31
Simplicity - Motor and Battery Wand, Standard or Rechargeable (excludes remote)		Pg 127 \$368
Simplicity 5 Channel Remote		Pg 127 \$91
Simplicity 6 Channel Remote with Timer		Pg 127 \$110
DC Power Supply/Transformer		Pg 127 \$77
14 Volt Charger for NiMH Rechargeable Motor		Pg 128 \$28

Odysee Cellular Blinds

Odysee Cellular Blinds HARDWARE SYSTEM

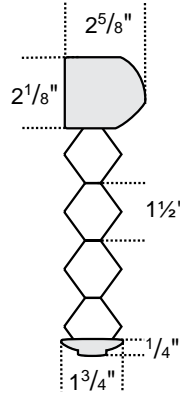
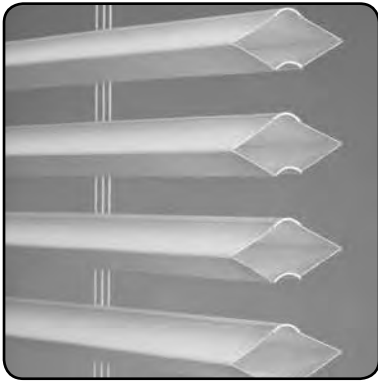

Odysee Cellular Blind Rail Dimensions

- Depth of head rail: 2⁵/₈"
- Height of head rail: 2¹/₈"
- Height of cell: 1¹/₂"
- Depth of bottom rail: 1³/₄"
- Height of bottom rail: 1/4"

Hardware Features

Hardware colors for all Odysee Cellular Blinds	<ul style="list-style-type: none"> • White head rail and bottom rail. The head rail includes a color matched fabric head rail insert strip. • PowerTouch Wand is white • Operating cord and cord tensioner are white. • There may be a gap from the head rail to the top vane (when the vanes are fully expanded) could be up to 3/16". The lip on the back of the head rail will prevent "view through" to the outside.
--	--

Mounting Dimensions

Odysee Cellular Blind Hardware System

Inside Mount

Minimum Shallow Mount	1 1/4"
Minimum Flush Inside Mount	2 7/8"
Minimum Rear Vane Clearance	1/8"

Outside Mount

Minimum Shallow Mount	1"
Minimum Flush Inside Mount	2"
Minimum Outside Mount	1/8"

Side Mount

Minimum Shallow Mount	1 1/2"
Minimum Flush Inside Mount	2 5/8"
Minimum Outside Mount	1/8"

Finished Dimensions

Odysee Cellular Blind Hardware System

Inside Mount

- Head rail* unit ordered width less: 3/16"
- Blind length up to 1 5/8" more than ordered length; bottom vane may not fully extend when blind is fully lowered
- Fabric width ordered width less 1/2"

Outside Mount

- Head rail* unit ordered width plus: 3/8"
- Blind length up to 1 5/8" more than ordered length
- Fabric width ordered width

* Head rail measurements include endcaps. Width and length measurements may vary +/- 1/8"

Odysee Cellular Blinds HARDWARE SYSTEM

Applications

- Standard Rectangular
- PowerTouch™ Rechargeable is standard for shades up to 72" x 84"

Fabric Collections

You can select fabrics from two collections:

- **Standard and Natural Textures Collection:** Solid and patterned light filtering and room darkening colors.

Operating Cords (Optional)

- The cord loop is made of white nylon.
- Standard cord placement is right. Please specify location when ordering.
- Cord Loop System cords come in 2 foot to 15 foot lengths in 1 foot intervals. Please specify length when ordering.

Standard loop sizes are as follows:

Blind Length	Standard Loop
Up to 36"	2' (24")
36" to 60"	3' (36")
60" to 84"	4' (48")
84" to 108"	5' (60")
108" to 120"	6' (72")

Vane Stack

Odysee Blinds are designed for both function and aesthetics with the opening and closing of the vanes, providing a view-through to the outside. While an Odysee Blind can be raised and lowered, a raised blind may result in a wavy stack resulting from the accumulation of aluminum lifters located on the cords. The aluminum lifters allow the vanes to be opened and closed



Stack Height

All measurements include head and bottom rails.

Blind Length	Stacking Height
Up to 12"	3¼"
12½" to 24"	4¼"
24½" to 36"	5¼"
36½" to 48"	6¼"
48½" to 60"	7¼"
60½" to 72"	8¼"
72½" to 84"	9¼"
84½" to 96"	10¼"
96½" to 108"	11¼"
108½" to 120"	12¼"

Odysee Vane Characteristics

What size is a vane?

A vane is 1" high.

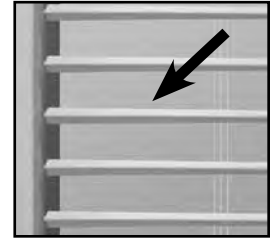

Vane Flare

A certain level of flare is common on the sides of the vane. This characteristic is designed into the blind to assist in closure when the vanes are fully expanded.

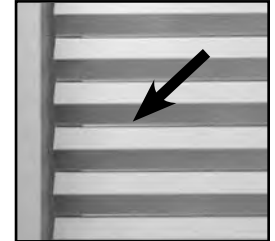

Vane Gap

It is not uncommon to have very small gaps between the vanes; however, the gaps should not be large enough for you to "view through" to the outside.

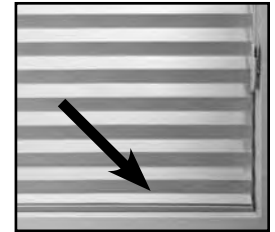

Bottom Vane

The bottom vane is designed to stay flat and may appear extra. In addition, some blinds may need an extra vane in order for the blind to reach the bottom sill. When the vanes are expanded, the extra vane may be partially compressed because of the size of the window.



What do I do if an expanded vane is pushed in?

If the vane is pushed in, do not raise the blind. Carefully push the vane out with your finger or the eraser end of a pencil.

What do I do if the vanes do not expand or compress uniformly?

If one or more vanes hang up when opening or closing the blind, you can reset the vanes by toggling the cord loop back and forth.

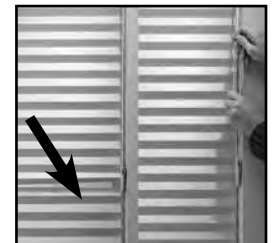

Are there color differences between Light Filtering and Room Darkening Vanes?

Due to the differences between the light filtering and room darkening base material, slight color variations may exist. These slight color variations are within established industry standards and should be expected.

Odysee Cellular Blinds

CORDLESS POWERTOUC

Cordless PowerTouch Push Button Control Applications

- Standard Rectangular
- PowerTouch™ Rechargeable is standard for shades up to 72" x 84"

Odysee Cellular Blinds can be fabricated with the Cordless PowerTouch Push Button Control option.

The PowerTouch option is an easy, cord free motorized operation for the budget savvy homeowner. PowerTouch uses Simplicity motors and components.

PowerTouch Operation

Press and hold the up or down button on the pendant to adjust the blind position. Release the button to stop the blind at your desired position. No programming is required.

The PowerTouch system is most convenient for adjusting the vanes between open and closed; but can also be used to raise and lower the blind.

All fabrics will use white wand and pendants.
All standard Odysee discounts apply to PowerTouch Blinds.

PowerTouch Appearance

- The PowerTouch wand and pendant is attached to the head rail and requires no additional mounting.
- The wand and pendant hangs down the front of the blinds from the head rail. The wand does not touch the fabric.
- Pendant is 2½" long.
- The pendant does not need to be mounted to the wall to operate the blind.

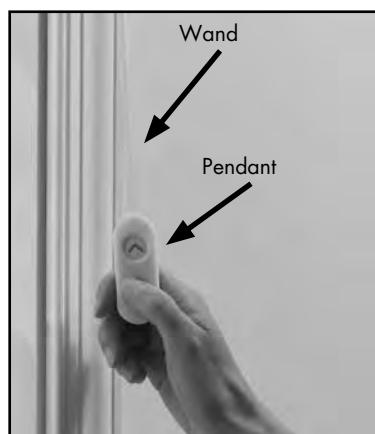

PowerTouch Rechargeable NiMH Battery Wand is Standard

Please see page 128 for more information.

PowerTouch Color Options

- All Odysee Blinds will use white wand and pendants.

PowerTouch Wand Length

- The standard length of the wand will measure half the ordered length of the blind.
- Maximum wand length is 56" including the pendant.
- Custom wand lengths are available in 1" increments up to 56", specify when ordering. Custom wand length surcharge of \$31.00 applies.

PowerTouch Wand and Pendant Location

The standard location for the wand and pendant is on the right. Please specify location when ordering.

Mounting Requirements for Odysee Cordless PowerTouch Blinds

- No special installation hardware or wiring requirements are needed to install Odysee Cordless PowerTouch Blinds.
- The wand and pendant do not need to be mounted to operate the blind.

Cordless PowerTouch Blinds Reloadable Battery Wand (Optional)

The battery wand is wall or ceiling mounted utilizing white battery wand clips. The 12 volt battery wand measures 17¼", and comes with eight alkaline batteries, and is white in color.

The battery wire is 10" long. A 48" extension wire is available.



PowerTouch Wand Battery Life and Replacement

Eight alkaline batteries are included with the battery wand. The battery life will vary based on the type of window covering selected, the size and weight of the window covering and the number of times you operate the blind on a daily basis.

Comfortex will warranty batteries for up to 3 months from date of purchase.

DC Power Supply/Transformer

12 Volt DC power supply/transformer is available and requires a standard power outlet to power the motor. The transformer is an alternative to a battery wand. Each transformer can power a single blind. The power supply must plug in to the motor. The DC power supply is white and comes with a 80" wire. The dimensions are 1⅞" wide x 3¼" long x 1¼" deep.

Odysee Cordless PowerTouch Blinds Warranty

Please see page 135 for complete warranty information.

Odysee Cellular Blinds

SIMPLICITY MOTORIZED ODYSSEE CELLULAR BLINDS

Motorized Odysee Cellular Blinds

Odysee Cellular Blinds can be motorized with Simplicity Radio Controlled Motors.

Simplicity Motor Program

The Simplicity Motor program features a battery powered motor utilizing a single 12 volt battery wand or DC (Plug-in) transformer. Simplicity motors are compact and use a radio controlled remote to raise or lower the blinds.

Mounting Requirements For Motorized Odysee Cellular Blinds

No special installation hardware or wiring requirements are needed to install motorized Odysee Blinds. See page 124 for mounting information.

PowerTouch Rechargeable NiMH Battery Wand is Standard

Please see page 128 for more information.

Simplicity Reloadable Battery Wand (Optional)

Batteries are needed to operate Simplicity motors. The battery wand is can be clipped to the head rail or wall or ceiling mounted utilizing white battery wand clips. The 12 volt battery wand measures 17¼", and comes with eight AA alkaline batteries, and is white in color.

The battery wire is 10" long. A 48" extension wire is available.



Simplicity Motor Battery Life and Replacement

Eight alkaline batteries are included with the wand.

The battery life will vary based on the type of window covering selected, the size and weight of the window covering and the number of times you operate the shade on a daily basis. For example, a 36" x 60" single honeycomb shade operated twice daily will have a battery life which lasts up to 18 months.

Comfortex will warranty batteries for up to 3 months from date of purchase. Batteries are not covered by the warranty.

Simplicity Motor Hand Held Remotes

5 Channel Remote

The **5 Channel (5C) remote** can operate up to five shades individually or in groups. **WHEN ORDERING PLEASE SPECIFY WHICH CHANNELS ARE ASSIGNED TO EACH SHADING OR GROUP OF Shades.**

For example; program line 1 to channel 1, line 2 and 3 to channel 2, etc. If no channels are assigned at time of order, all shades will be programmed to Channel 1.



Simplicity 5C remotes and holders are white or black in color. The remote comes with a holder which can be mounted to a wall for easy storage. The range of the remote is approximately 80 feet.

6 Channel Timer Remote

The **6 Channel (6C) timer remote** combines the functionality of a fifteen channel hand-held control with the convenience of a programmable timer.

- The 6C timer remote allows for 18 different scheduled actions each day of the week.
- Manual function disables the timer and the remote then operates as a 1-channel hand held remote.



WHEN ORDERING PLEASE SPECIFY WHICH CHANNELS ARE ASSIGNED TO EACH SHADING OR GROUP OF SHADES.

For example; program line 1 to channel 1, line 2 and 3 to channel 2, etc. If no channels are assigned at time of order, all shades will be programmed to Channel 1.

Simplicity remotes and holders come in white. The remote comes with a holder which can be mounted to a wall for easy storage. The range of the remote is approximately 80 feet.

DC Power Supply/Transformer

12 Volt DC power supply/transformer is available and requires a standard power outlet to power the motor. The transformer is an alternative to a battery wand. Each transformer can power a single shading. The power supply must plug in to the motor. The DC power supply is white and comes with a 80" wire. The dimensions are 1⅞" wide x 3¼" long x 1¼" deep



Odysee Cellular Blinds

Odysee Cellular Blind RECHARGEABLE SIMPLICITY MOTORIZED BLINDS

Rechargeable Simplicity Motors

The Simplicity Motor program features a battery powered motor utilizing a rechargeable battery wand. Simplicity motors are compact and use a radio controlled remote to raise or lower the shades.

Rechargeable Motorized Lift Systems are not offered on sizes within the shaded area on the Standard Rectangular price grids.

Applications

- Standard Rectangular

Simplicity Rechargeable Battery Wand

The wand will be concealed in the head rail on shades over 28" wide. The battery wand measures 22", comes with NiMH rechargeable batteries, and is white in color. For blinds less than 28" wide, the rechargeable battery wand can be clipped to the wall or ceiling mounted utilizing supplied battery wand clips.

Rechargeable battery wand comes fully charged from the factory.



Rechargeable Battery Wand Concealed in Head rail.
(Minimum width of 28" required)

Simplicity Motor Hand Held Remotes

The same remotes used for Simplicity motorized blinds can be used for Rechargeable Motorized Odysee Cellular Blinds, see page 127 for more information and options.

Mounting Requirements

No special installation hardware or wiring requirements are needed. See page 124 for mounting information.

Battery Charger

14 Volt charger requires a standard power outlet to recharge the battery wand. Must specify charger when ordering a Simplicity Rechargeable Wand Shade. The charger plugs into the charger port. The charger is black and comes with a 156" wire. The dimensions are 1 7/8" wide x 3 1/4" length x 1 3/4" deep.

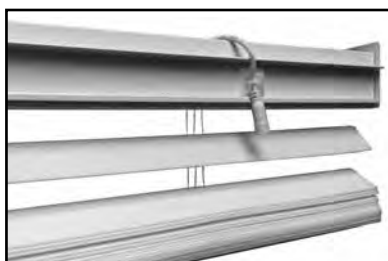

Charging Port on Back of Head rail



Simplicity Rechargeable Battery Life

Rechargeable batteries are included with the motor.

The average battery charge will last 6-12 months based on an average sized shade raised and lowered once per day. The life of a single charge will vary based on the type of window covering selected, the size and weight of the window covering and the number of times the cellular blind is operated on a daily basis.

The battery can be recharged up to 500 times. It takes approximately 5 hours to recharge the motor when fully depleted.

Retrofit Existing Standard Simplicity Motorized Shades with Rechargeable Batteries

Cellular shades made with Standard Simplicity Motorization can be retrofitted with the Rechargeable Simplicity Motorization Battery Wand. The Rechargeable battery wand is 22" long, comes with 10 NiMH batteries, and is white in color. Battery wands are charged at the factory.

Retrofit Ordering Requirements:

- Rechargeable battery wand with clips (one per shade)
- Rechargeable battery charger (one or more per order, or as needed)
- Charge port mounting base (optional)

Please contact customer service for more information.

Operating Odysee Blinds

- A single cord loop and clutch combination is used to raise and lower the blinds, as well as open and close the vanes.
- To compress the vanes or lower the blind, pull on the rear of the cord loop. To expand the vanes or raise the blind, pull on the front of the cord loop.

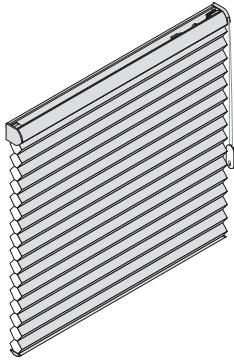

Privacy Position
(Vanes expanded)

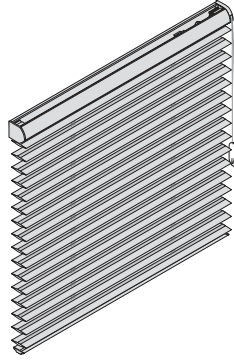

View-Through Position
(Vanes compressed)

If at any time the vanes do not expand or compress uniformly you can reset the vanes by toggling the cord loop. Opening and closing the vanes should re-align them with uniform expansion or compression.

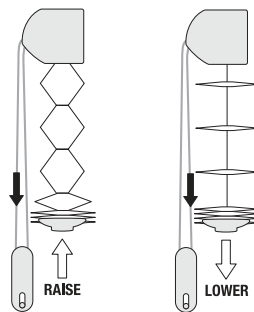

Bottom Rail

Odysee Cellular Blinds feature a creamy white bottom rail.

When the vanes are expanded (closed), the bottom rail touches the window sill. When the vanes are compressed (open), the bottom rail may lift off the sill slightly. This is normal.

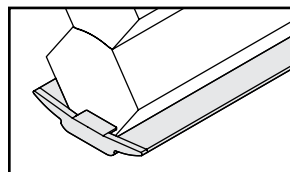

Odysee Certified Fabrics

The GREENGUARD Environmental Institute has established performance based standards to define goods with low chemical and particle emissions for use indoors.

Odysee fabrics have earned the following certifications:

- GREENGUARD Indoor Air Quality Certified® certification for low emitting interior building materials, furnishings, and finish systems.
- GREENGUARD Children & SchoolsSM product certification for low emitting interior building materials, furnishings, and finish systems used in educational (day care and K-12) environments.

Measuring Instructions for Odysee Cellular Blinds

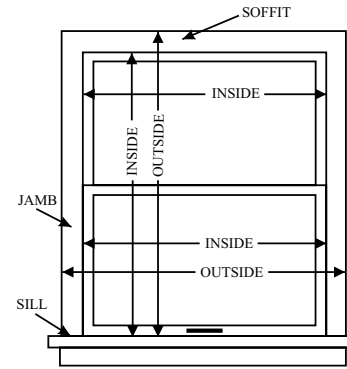

Comfortex accepts measurements down to 1/16" increments.

Inside or Side Mount

Use a steel tape to measure the opening at three different places, and use the narrowest dimension when ordering. Be exact! The factory will make the vanes narrower so they will not rub against the window casing. Measure the height of the window from the top (soffit) down to the sill.

Outside Mount

Use a steel tape to measure the exact height and width of the area to be covered. It is recommended that the blinds overlap the window by at least 1 1/2" on each side. When installation has no sill, allow the blind to overlap the bottom of the window casing by at least 1 1/2". Blind fabric will measure width indicated on the order form.

Cleaning and Care of Odysee Cellular Blinds

Regular feather dusting or vacuuming will keep Odysee Cellular Blinds looking new for years.

Odysee Cellular Blinds can be spot cleaned. Gently blot the stain with a clean, non-alcohol baby wipe. Instead of a baby wipe, you may use a clean white cloth with a mild cleaning solution. Support the fabric from behind using another clean, dry cloth. Clean the fabric using a gentle blotting action. Do not rub the fabric. Any abrasive action may cause the fabric to pill or distort. Allow the fabric to air dry with vanes expanded.

Forced air can also be used to blow out dirt and debris from within the vanes using clean compressed air or a hair dryer on the COOL setting.

Odysee Cellular Blinds can also be ultrasonically cleaned. Do not immerse the head rail. Comfortex acknowledges these cleaning methods as being safe and effective. We cannot attest to the quality of equipment or services provided by any independent cleaning facility.

Cellular Shade

MEASURING INSTRUCTIONS

Comfortex accepts measurements down to $\frac{1}{16}$ " increments.

Inside Mount

Use a steel tape to measure the opening at three different places, and use the narrowest dimension when ordering. Be exact! The factory will make the shade $\frac{3}{16}$ " narrower so it will not rub against the window casing. Measure the height of the window from the top (soffit) down to the sill.

Outside or Ceiling Mount

Use a steel tape to measure the exact height and width of the area to be covered. It is recommended that the shades overlap the window by at least $1\frac{1}{2}$ " on each side. When installation has no sill, allow the shade to overlap the bottom of the window casing by at least $1\frac{1}{2}$ ". Shade fabric will measure width indicated on the order form.

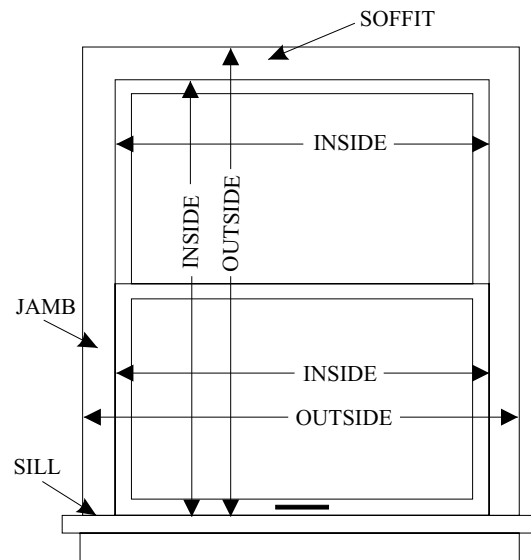

Measuring for Specialty Shapes

Templates are required with some specialty shade orders. Consult the individual product sections of this guide for specifics regarding accurate measurements and mounting information.

Arches and Quarter Round Circles

- Measure the window height and width appropriately for an inside or outside mount.
- With perfect arches, the height will be one half the width. With perfect quarter rounds, height will equal width. If the arch or quarter round is perfect, **a template is not required.**
- Windows with imperfect arch measurements do not maintain the height/width relationship. Templates **are required** for these windows.

Trapezoids

- Measure the window height and width appropriately for an inside or outside mount. For outside mounts, remember to add the desired amount of overlap.
- Either the top or bottom of the shade is sloped or angled.
- Measure all four sides for accurate fabrication. Provide all measurements. **Templates are not required.**
- The slope angle must be measured with a protractor. Slope is the angle between slope and a horizontal line. The maximum slope is 30 degrees.

Octagons

- Measure the window height and width appropriately for an inside or outside mount. Be sure to measure the width at the shade's widest point.
- Provide the width, length and the length of one side when ordering.

Making the Perfect Template

Tape brown craft paper over the window opening. Be sure to allow plenty of overlap and check to see that the paper is smooth and pulled taut. Do not use newspaper as the ink can rub off on fabric. Do not use paper that has been folded. Notice the outline of the framework superimposed on the template as the light filters through the window. You may create the template in one of two ways:

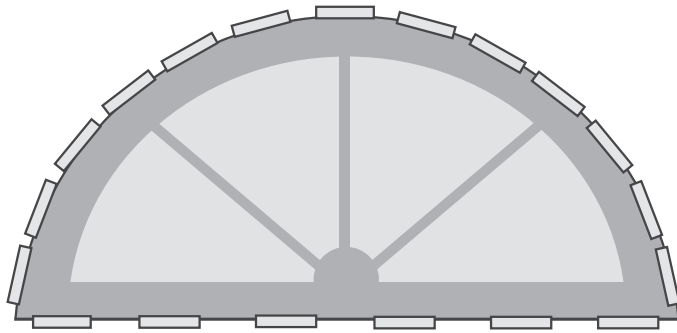

Trace the outline of the window with a pencil and continue along the side of the window frame. Once the window is completely traced, remove the craft paper from the window. Cut out the traced shape with a pair of scissors.

You may choose to skip tracing the window outline with a pencil and cut out the shape immediately with a razor knife.

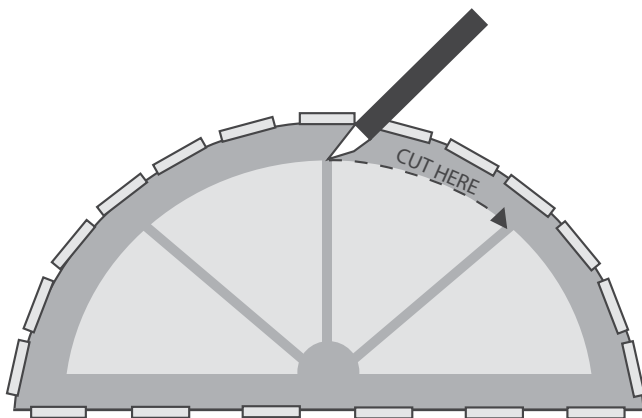

Once your template is cut, double check its width and height with your initial measurements. Test the template by placing it in the window. Check for light gaps, uneven cutting of curves etc. Trim or remake if necessary.

With arch top shades, fold the template in half. Check the outline of the curve for smoothness, light gaps and curve continuity. Place the template in the window and check it for light gaps or uneven cutting of curve. Trim or remake it if necessary.

On the front of the template, mark the shade measurements along with your company name, account number, sidemark, shade style and color. Be sure to indicate inside or outside mount, the room side and which ends of the template are top and bottom. Do not take any deductions on inside mount shades. The factory will make all necessary allowances for inside mounts.

Remember: The quality of the finished shades depends heavily on the quality of the template supplied. Do not hesitate to remake a template if you feel uncomfortable of the quality of your first attempt.

Template Kits: Comfortex offers template kits which includes brown craft paper, razor knife, instructions and order form. Please contact Customer Service or visit www.comfortex.com to order. Stock number: 751000

Child Safety

Comfortex has a long history of designing new child-safety products and is proud to provide a leadership role in cooperating with the Consumer Product Safety Commission (CPSC) for the development of policies and guidelines for the industry by serving on the WCMA Standards Development Committee.

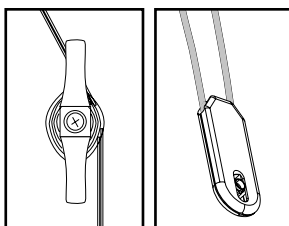

Cord Cleat

Cord Tensioner

All Comfortex products have been fully tested and proven to comply with the current WCMA Standards for safety of corded window coverings.

Be aware that it is possible for children to become entangled in window covering cords. To reduce the risk of accidents, all cords must be kept out of the reach of children.

A cord cleat or cord tensioner is an effective way to implement this essential precaution. Please use them.

To mount the cord cleat at a safe height, take into account furniture or other objects upon which a child may climb. Then, after the use of the blind, simply wrap the excess cord around the cleat.

Conditions of Sale

All Comfortex products are custom fabricated to your exact specifications. We cannot accept responsibility for errors in ordering or cancellations and charges after the order is in production.

Policies

Our policies are designed to provide a guide for doing business with Comfortex. Our first priority and number one policy is to provide the highest level of service and total satisfaction.

Freight

Comfortex will ship all orders for fabricated shades or blinds freight free via UPS, FedEx Ground or other similar method within the continental United States*.

A \$3.75 per unit transportation surcharge will be added to all fabricated product orders, within the continental United States, including shades/blinds, vane packs, individual vanes, tracks, valance and cut yardage orders.

In addition, a \$70.00 Common Carrier surcharge** will be added for all orders shipped within the continental United States*, that include shades, blinds or valances with widths of 98" or more and are required to ship by motor freight. Exception: Verticals with lengths of 84" or more, and Roman Shades with widths of 94" or more are required to ship by motor freight.

***Hawaii:** Shipments to Hawaii will incur a freight charge of \$50.00 per unit when shipped from within the Continental US.

****In Addition,** a \$110.00 Common Carrier surcharge for

! WARNING



The cords on this product present a potential strangulation hazard.



For child safety, consider cordless alternatives or products with inaccessible cords.

! ADVERTENCIA



Los cordones de este producto representan un peligro potencial de estrangulamiento.



Para la seguridad de los niños, utilice alternativas sin cordón o productos cuyos cordones sean inaccesibles.

! MISE EN GARDE



Les câbles de ce produit représentent un danger potentiel de strangulation.



Pour la sécurité des enfants, pensez au sans fil, ou procurez-vous des produits dont les câbles ne sont pas accessibles.

oversized shipments will be added to orders shipping to Hawaii.

***Alaska:** Shipments to Alaska will incur an \$8.00 per unit transportation surcharge when shipped from within the Continental US.

****In addition,** a \$110 Common Carrier surcharge for oversized shipments will be added to orders shipping to Alaska from within the Continental US.

Canada: Shipments to Canadian Dealers will incur a \$6.00 per unit transportation surcharge when shipped from within the Continental US. In addition, a \$110 Common Carrier surcharge for oversized shipments will be added to orders shipping to Canada from within the Continental US.

Freight continued

Comfortex Mexico Plant: All shipments from our Mexico plant to Alaska, Hawaii or anywhere outside the Continental US will incur all freight charges (freight forwarder needed if shipping to another country).

All Other Countries: All United States dealers requesting to ship orders outside the United States must provide a freight forwarder for Comfortex to ship to within the continental United States. Comfortex cannot ship directly to your customers located outside the United States.

Please Note: Comfortex reserves the right to select another carrier, modify shipping terms or change freight policies without notice.

Service and Repair

Service may be obtained by contacting our Customer Service Department. No products, parts, components or other materials will be authorized for return or repair without prior approval from Comfortex. A Return Authorization (RA) may be obtained by contacting our Technical Service Department. In order to provide the quickest service possible, please have your Comfortex Work Order number and original order information available when you call.

Charged Marketing Materials

All charged marketing materials will incur freight charges. Marketing materials may ship on separate days, from different locations. Freight charges are calculated per package, not per order.

Specifications

All Comfortex products are designed and tested to perform as intended within established, published parameters. Requests for "custom fabrication" of products outside of our published specifications may be considered, but are at the discretion of the Comfortex Technical Services department. Restrictions and additional charges apply.

Download installation instructions, order forms or additional price list copies on the Comfortex OnDemand Library or www.comfortex.com/comfortex-dealers in the Dealers Resource Center.

Odysee Fabric Color Variations

Due to the differences between the light filtering and room darkening base material, slight color variations may exist. These slight color variations are within established industry standards and should be expected.

Custom Graphics Cellular Shades Color

Warranty

Comfortex utilizes state of the art technology to provide you Custom Graphics Shades within 2 Delta-E (DE) of the sample fabrics found in the Comfortex Collections Cellular and Pleated Sample Book. When viewed under different lighting sources such as fluorescent, incandescent, halogen, ultraviolet and others, fabrics may appear different to the eye. Comfortex utilizes the worldwide lighting standards of Daylight 65 (D65) as our official standard for measuring and qualifying color accuracy, because D65 daylight bulbs best represent actual "daylight" illumination. Slight color variations (under 2 DE) are within established industry standard and should be expected.

This warranty is in addition to Comfortex limited lifetime warranty.

Scotchgard™ Warranty

Comfortex Window Fashions provides a limited warranty for fabrics treated with Scotchgard™ Protector against permanent stains for a period of 1 year from the date of original purchase.

This warranty excludes conditions or damages resulting from accidents, alterations, exposure to the elements, and exposure to any and all natural and manufactured excessive heat sources, or failure to follow the Installation and Care instructions. This warranty also excludes fabric submerged in water or cleaning solutions, or treated with household products that may alter or deplete the effectiveness of the treated fabric. In addition, the following types of stains are excluded from this limited warranty: pet stains, bodily fluids, stains caused by wine, bleach, plant fertilizers, acne medication, misuse or abuse. This warranty is not a cleaning contract and does not cover the cleaning of fabrics that are soiled or discolored through daily use. This warranty coverage is limited to residential use and is not transferable.

The following are the recommended cleaning and care instructions for window treatments with fabric treated with Scotchgard™ Protector.

- Gently blot liquid stains immediately with a clean, white cloth.
- If stain remains, prepare a solution of ¼ teaspoon of clear, non-bleaching dish detergent mixed with 1 cup of lukewarm water. Dampen a clean white cloth and gently blot the stain.
- Do not overwet the fabric or excessively rub the stained area.
- See the Installation and Care instructions for complete details.

For additional assistance with stain removal, call the Scotchgard™ Protector Service Center at 1-800-433-3296. Customer Care representatives are available Monday through Friday, 8am to 6pm CT.

Should the results of the cleaning and care instructions not result in the removal of permanent stains covered by this limited warranty, Comfortex will retreat or replace the fabric, at its discretion, for a period of 1 year from the date of original purchase. Customer must provide proof of purchase and provide proof the stain occurred during the warranty period. Shipping and handling costs to send the window treatment back to Comfortex are the responsibility of the customer.

This warranty gives you specific legal rights, and you may also have other rights which vary from state to state.

Cellular, Pleated and Prelude Shades Odyssey Cellular Blinds Warranty Information

Comfortex warrants that its window treatments will be free from defects in materials and workmanship for as long as the original residential purchaser owns the product, provided that the product was installed properly and in accordance with the installation instructions. The Limited Lifetime Warranty is extended to the original residential purchaser only, in the original window for which it was installed.

The Warranty does not include any conditions or damages resulting from accidents, alterations, misuse, abuse, misapplication, improper handling, installation, repairs, operation, cleaning, exposure to any and all natural and manufactured excessive heat sources. (Excessive heat sources include, but not limited to; magnification of sun light through cubes of glass, heaters of any kind, ovens, candles, lighting fixtures, etc.) This warranty does not cover variation in fabric color, grain, or texture in natural wood products nor excessive warping of wood slats in high humidity areas. Loss of pleating is not covered if the product is not being cycled (held in the raised position a portion of the time). Normal wear and tear is not covered.

All moving parts, such as cords and strings (internal and external), will eventually wear out and fabric may fray. Comfortex considers these things as normal wear and tear and will carry a three year Limited Warranty. All fabric, including fabric vanes, panels, inserts, and shades carry a five year Warranty. Fabric cell separation is covered for a lifetime. See Comfortex Standard Return and Repair Policy for more details.

This Limited Warranty does not cover transportation costs to and from the retailer, costs of removal, re-measure, reinstallation of product, or any incidental or consequential damages.

If a Comfortex product is found to be defective in materials or workmanship, we will, at our discretion, repair, replace or refund the cost of a product which fails to conform to this Limited Warranty. Colors vary from lot to lot and may not exactly match sample swatch, sample book, or previous purchases. Discontinued components or color selections will be replaced with the closest equivalent current product. This shall be your sole remedy under this Limited Warranty.

To obtain service, contact the Dealer from whom you purchased the product.

This Warranty is exclusive and in lieu of all other obligations, liabilities or warranties. In no event shall Comfortex or its licensed fabricators or distributors be liable for incidental or consequential damages, or for any other damage, loss or expense, cost or fee associated with such damage. In some states, exclusions for incidental or consequential damages

are not allowable. Comfortex Dealers and Fabricators must use safety devices supplied by Comfortex in accordance with Window Covering Safety Counsel guidelines.

This Warranty gives you specific legal rights, and you may also have other rights, which vary from state to state. Policy is subject to change without notice.

This Limited Warranty is exclusive of commercial use. Contact Comfortex Technical Service for more information. No agent, representative, dealer or unauthorized employee has the authority to increase or alter the obligation of this Warranty.

This Limited Warranty supersedes any previous versions.

Motorized Cellular and Pleated Shades and Odysee Cellular Blinds Warranty

Simplicity Motors including PowerTouch and Rechargeable Simplicity Motorization

We offer a 5 year warranty on all motors and controls. Specifically, we warrant the Simplicity motors and controls to be free from defects in material and workmanship under normal and proper use for a period of 5 years commencing with the date stamped on each product. If the Simplicity product fails within this 5 year period, we will repair or replace it free of charge through your end product supplier. Batteries are not covered by the warranty.

©2018 COMFORTEX CORPORATION

™ is a trademark of Comfortex Corporation. ® is a registered trademark of Comfortex Corporation. The GREENGUARD INDOOR AIR QUALITY CERTIFIED Mark is a registered certification mark used under license through the GREENGUARD Environmental Institute. GREENGUARD Children & SchoolsSM is a service mark used under license through the GREENGUARD Environmental Institute. Energizer® is a registered trademark of Energizer Holdings, Inc. Symphony® and Soprano® are registered trademarks of Comfortex Corporation. Symphony® is covered by U.S. Patent Nos. 5,193,601 and 4,974,656 respectively. Ovation™ Cellular Slider is covered by one or more of the following U.S. Patent Nos.: 4,862,941, 4,858,668, 4,915,153, D346,032, D324,108, 4,450,027, 4,631,108, 4,603,072, 5,690,778, 5,664,773, 6,319,586, 5,482,750, 5,601,885 and 4,631,217. SlumberShade™ is covered by U.S. Patent No. 8,371,355. Karma-Light™, PowerTouch™, Timeless Textures™, Debut™, Cordless Ultra™, Sunset™, Balcony™ and Ovation™ are trademarks of Comfortex Corporation. Other U.S. and foreign patents pending. All rights reserved.

Odysee is covered by U.S. Patent Nos. 5918655, 4372432, 4433765, 4623012, 5697630, 5058720, 5228491, 5375643, 5733632 and 5680891. Additional U. S. and foreign patents pending.



Odysee™ Cellular Blinds

What's Inside:

- Verona and Boutique Light Filtering and Room Darkening
- PowerTouch™ Rechargeable for Cellular Shades
- Simplicity Rechargeable Motorized Shades and Blinds
- Optional Scotchgard™ Stain Protection for Cellular Shades
- Prelude Cellular Shades
- Privada™ Privacy Pleated Shades
- Odysee™ Cellular Blinds
- Custom Graphic Shades
- Certified Best For Kids Products

 **MDS** Midwest
WINDOW FASHIONS Designer
Supply

www.midwestdesignersupply.com

 **Comfortex**
WINDOW FASHIONS

511005PL 04/18
Scotchgard™ is a trademark of 3M.

888-523-2611
262-524-1007 (fax)